

AKAI

STEREO INTEGRATED AMPLIFIER

AM-32 AM-52

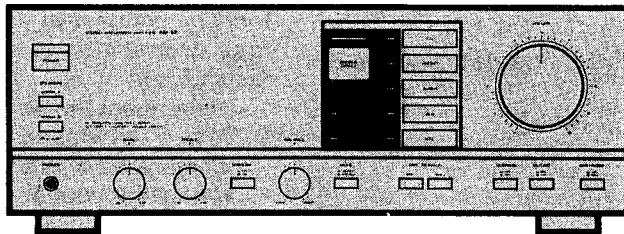

Operator's Manual **5**

This manual applies equally to models AM-32 and AM-52 except where otherwise noted. Illustration shows model AM-52.

English	Page	1~11
Français	Page	12~23
Deutsch	Seite	24~35
Nederlands	Pagina	36~47
Español	Página	48~59

1 This is the Akai Stereo Integrated Amplifier

Use this Akai amplifier in combination with the other components in the Akai Pro-series and you will have an excellent hi-fi system.

Features

- High power dual pole DC servo power amplifier
- SOURCE DIRECT switch (See page 9)
- SUBSONIC filter switch (See page 9)
- MUTING switch (See page 9)
- TAPE MONITOR switch (TAPE 1/TAPE 2 for AM-52/See page 7)
- STEREO/MONO MODE switch (AM-52/See page 9)
- A & B SPEAKER switches (See page 9)
- MC cartridge capable high-gain type PHONO equalizer amplifier (See page 9)
- LOUDNESS switch (See page 9)
- BASS and TREBLE tone controls (See page 9)
- Electronic speaker protection circuit (See page 5)
- Large diameter speaker terminals (See page 4)
- DAT (Digital Audio Tape) deck jacks (See page 8)
- Exclusive adaptor input and output jacks (See page 8)
- Large capacity power supply section
- Low-noise Dual FET coupled type phono equalizer and power amplifier

Table of contents

Warning	1
What you should know to protect yourself	2
Making the right connections.....	3-4
Controls	5
Let's enjoy the music	6
Let's record.....	7
Expanding Your Hi-Fi system	8
The parts of the Akai Amplifier.....	9
Problem? Let's check	10
The speaker system	10
Specifications	11

WARNING

To prevent fire or shock hazard, do not expose this appliance to rain or moisture.

Power requirements

Power requirements for electrical equipment differ from area to area.

Please ensure that your machine meets the power requirements in your area.

If in doubt, consult a qualified electrician.

120 V, 60 Hz for USA and Canada

220 V, 50 Hz for Europe except UK

240 V, 50 Hz for UK and Australia

127 V/220 V, 50/60 Hz for Saudi Arabia.

110 V/120 V/220 V/240 V, 50 Hz/60 Hz convertible for other countries.

Voltage conversion (not on all models)

This machine can be set to 110 V, 120 V, 220 V or 240 V as required. Each machine is preset at the factory according to destination. However, if voltage conversion is necessary, follow the instructions below:

1. Disconnect the power cord.
2. With a flat bladed screwdriver, rotate the selector (located on the rear panel) so that the correct voltage for your area is displayed.

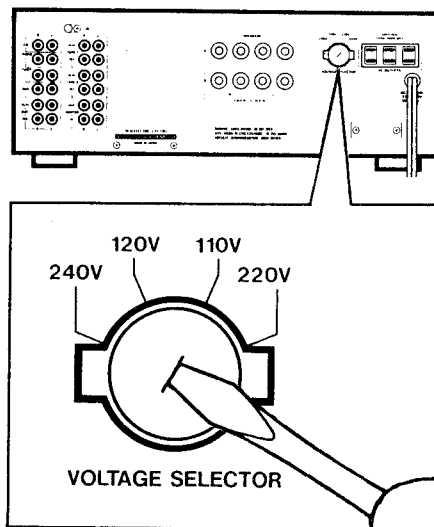

What you should know to protect yourself

Watch out! You might get an electric shock.

- Never touch the plug with wet hands.
- Always pull out by the plug and never the cord.
- Only let a qualified professional repair or reassemble the Akai Amplifier. An unauthorized person might touch the internal parts and receive a serious electric shock.
- Never allow a child to put anything, especially metal, into the Akai Amplifier.

Let's protect the Akai Amplifier too.

- Use only a household AC power source. Never use a DC power source.
- Make sure that the power consumption of each component does not exceed the wattage specified on the rear panel.
- If water is spilled on the Akai Amplifier, disconnect it and call your dealer.
- Make sure that the Akai Amplifier is well ventilated and away from direct sunlight. Be careful not to block the side ventilator of the Akai Amplifier.
- To avoid damages to the internal circuits and the external surface, keep away from heat (stoves, etc.)
- Avoid using spray type insecticide near the Akai Amplifier. It can damage the finish and might ignite suddenly.
- To avoid damaging the finish, never use denatured alcohol, paint thinner or other similar chemicals to clean the Akai Amplifier.
- Place the Akai Amplifier on a flat and solid surface.
- If you don't plan to use the Akai Amplifier for a long period of time, disconnect the power cord.

To enjoy the Akai Amplifier for a long time, please read this operator's manual thoroughly.

CAUTION

To prevent electric shock, do not use this polarized AC power plug with an extension cord receptacle or other outlet unless the blades can be fully inserted to prevent blade exposure.

Making the right connections

3

Before connecting

- Turn off all the components before connecting.
- Connect the power cord last.
- Make sure that you connect the white PIN-plug to the left (white) jack and the red PIN-plug to the right (red) jack.
- Connect everything securely. Loose connections can lead to distortion.
- To prevent damage to the cords, connect and disconnect by holding the plug and not the cord.
- Make sure that the power cords and the connection cords do not get tangled with each other. This can lead to distortion.
- Make sure to connect the output cord of the player system to the PHONO jacks. Do not connect any other component (such as a CD player) to these PHONO jacks.
- If the turntable you are using has a ground wire, connect it to the ground terminal of the amplifier.

AUX jacks

This is an auxiliary jack. Connect such components as a video disc player or cassette deck for playback to these jacks.

For dubbing from the input source to one tape deck (for AM-32) or two tape decks (for AM-52), we recommend using the AUX jacks for the input source.

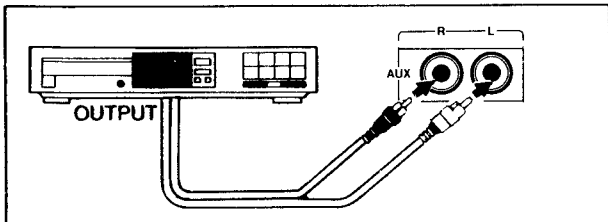

TAPE 2 jacks (for AM-52)

Connect the LINE IN jacks of the 2nd cassette deck (left and right) to the TAPE 2 REC jacks (left and right) of the Akai amplifier, and connect the LINE OUT jacks of the cassette deck (left and right) to the TAPE 2 PLAY jacks (left and right) of the Akai amplifier.

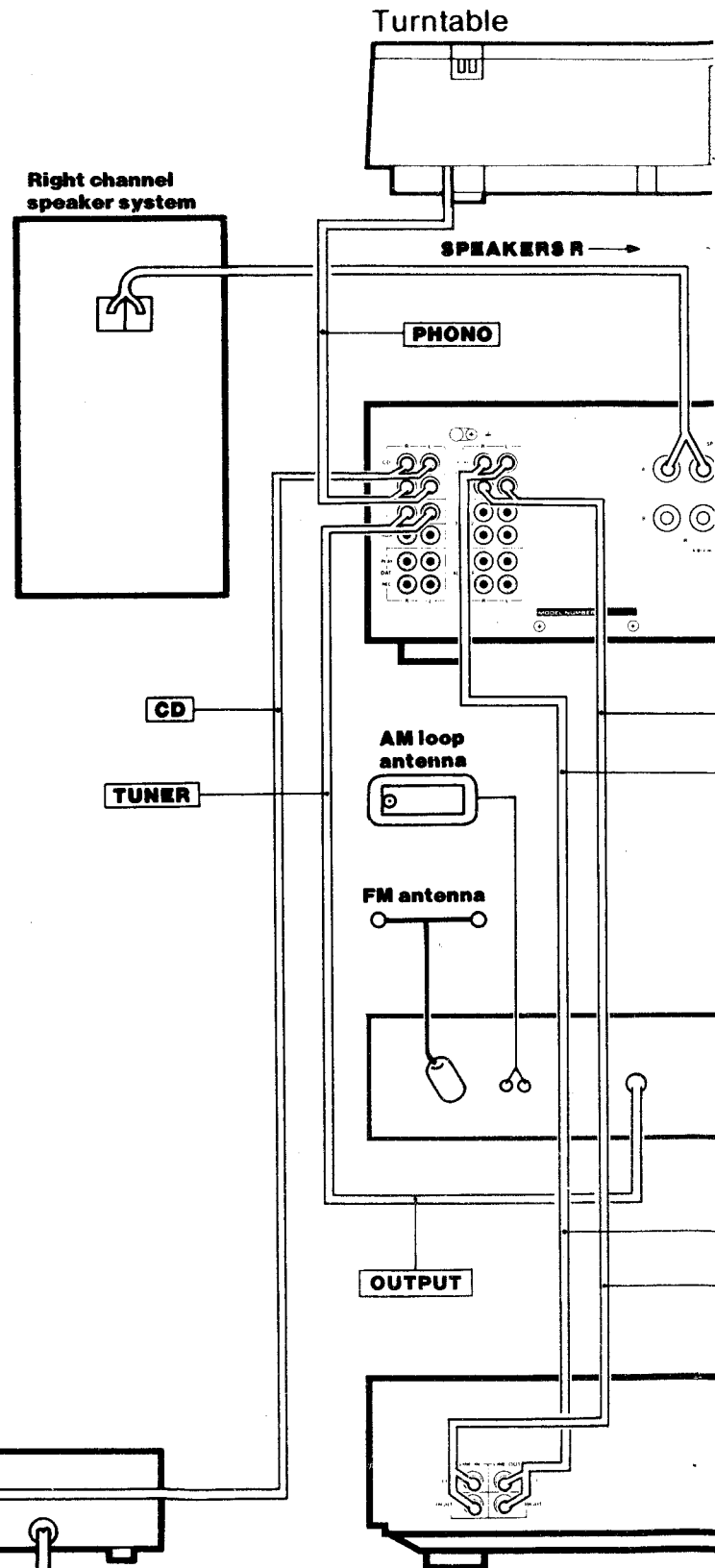
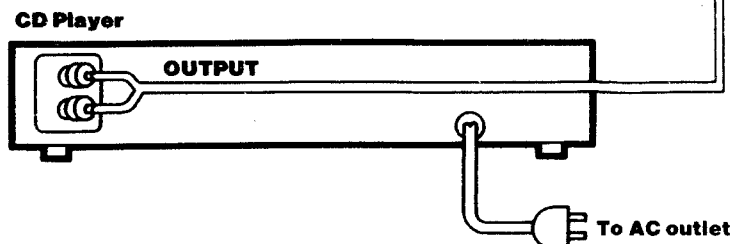
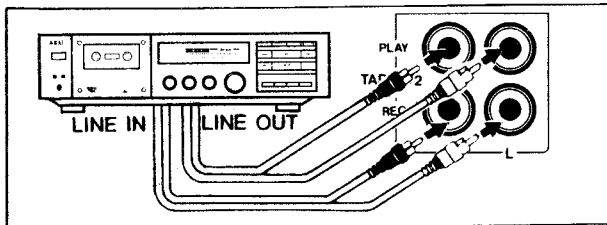

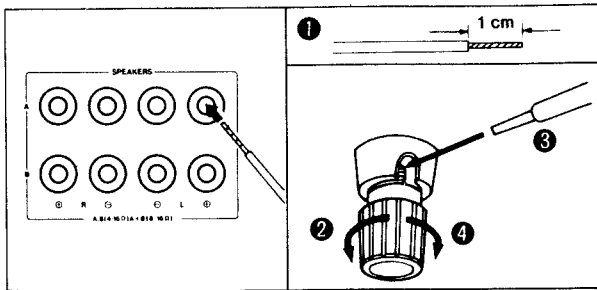

SPEAKER terminals

Be sure to connect the:

- ⊕ wires to the ⊕ terminals (red);
- ⊖ wires to the ⊖ terminals (black);

Left speaker to the Left (L) terminals; and Right speaker to the Right (R) terminals.

How to connect the speakers

1. Strip off 1 cm length of vinyl covering from the end of the speaker cord.
2. Loosen the Red and Black speaker terminals by turning them counter-clockwise. (These terminals cannot be removed.)
3. Twist wires firmly, then insert the speaker cords through the openings of the speaker terminal guards.
4. Turn the terminals clockwise to securely fasten the wires.

Note: For connection, we recommend the use of high power, large diameter-type speaker cords available in the Hi-Fi stores.

IMPORTANT: Do not cross connect speaker systems. Use either the A terminals or B terminals for connection of a pair of speakers. **Do not** connect one speaker to an A and the other to a B terminal.

Speaker impedance

Use speakers of 8 to 16 ohms impedance only. Refer to the marking on the amplifier's rear panel.

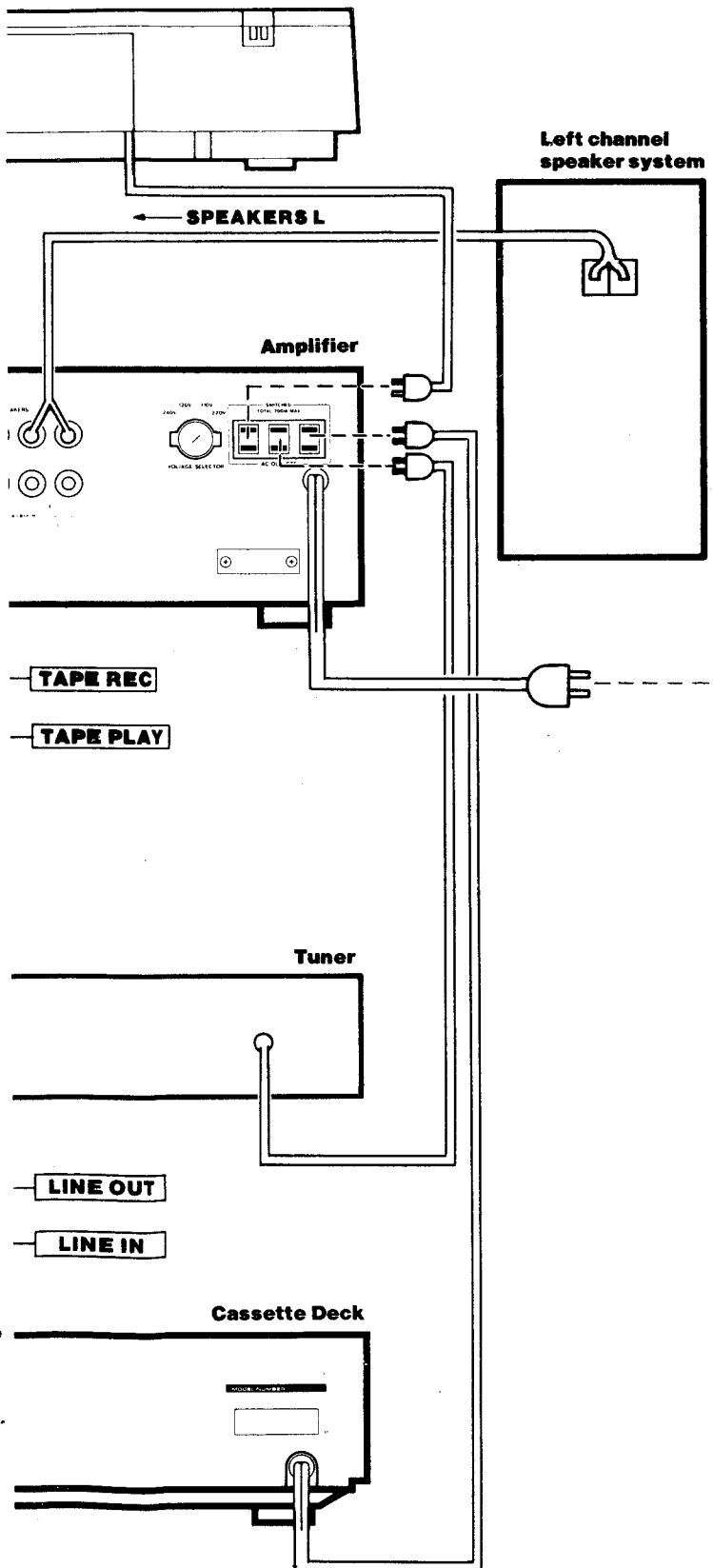

Power cord

Connect this cord to a household AC outlet. If using the Akai Audio Timer, connect the power cord to its AC OUTLET.

AC OUTLETS (not on some models)

Connect the power cords of the components connected to the Akai amplifier.

SWITCHED:

The power to these AC outlets is cut when the Akai amplifier is turned off. Make sure that the total power consumption of the components connected to these outlets **does not exceed 200 watts**.

On the ADAPTOR jacks

The Akai amplifier is equipped with special ADAPTOR jacks for connection of a graphic equalizer or audio processor. Refer to page 8.

The DAT jacks

Connect a DAT (Digital Audio Tape) deck or the 2nd (AM-32) or the 3rd (AM-52) cassette deck to these jacks. Refer to page 8.

Controls

5

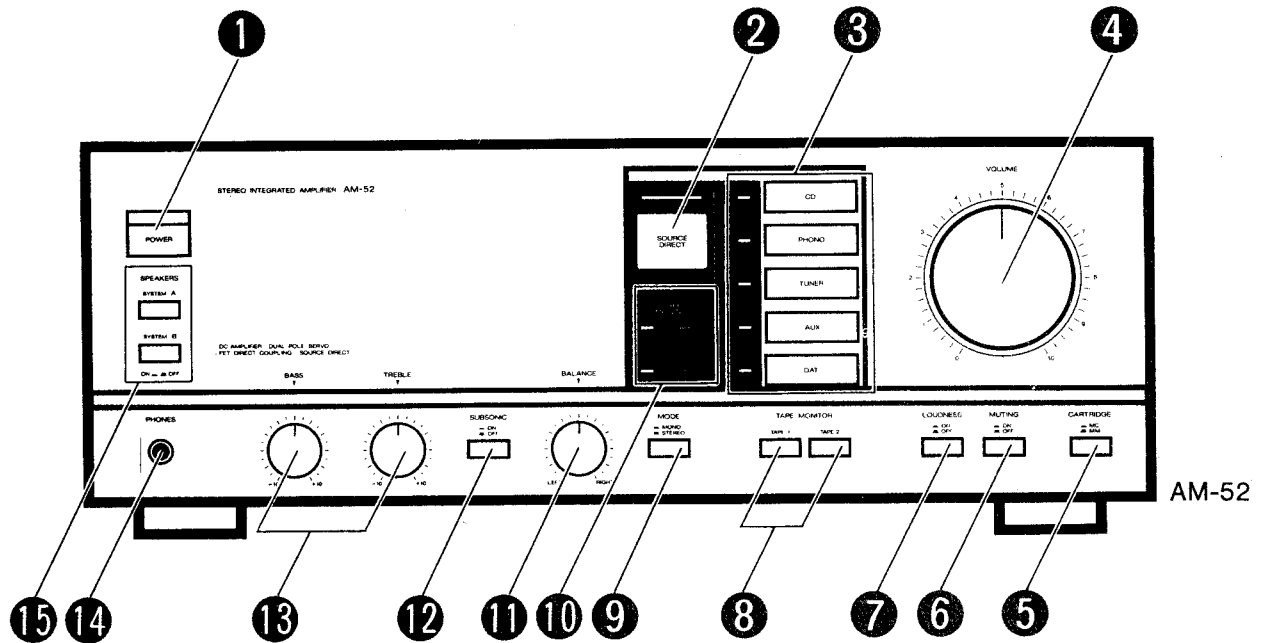







- 1 POWER switch and Indicator**
To turn on and off the amplifier. The indicator will light when the power is turned on.
- 2 SOURCE DIRECT switch and Indicator**
For clearer, low distortion playback of a compact disc, record, radio or DAT tape. The indicator will light when the switch is turned on.
* When the switch is turned on, the BASS and TREBLE tone controls and the BALANCE control are ineffective.
- 3 Input Select buttons (CD, PHONO, TUNER, AUX and DAT) and Indicators**
For selection of a playback source. The indicator of the button you choose will light up when depressed.
- 4 VOLUME control**
To increase or decrease playback volume level.
- 5 CARTRIDGE switch (MC/ MM)**
Adjust according to the type of cartridge you are using.
- 6 MUTING switch**
To reduce volume instantly during playback without using the VOLUME control.
- 7 LOUDNESS switch**
For instant compensation of tone setting at low volume level.
- 8 TAPE MONITOR switch (AM-52 only: TAPE 1/TAPE 2)**
For cassette tape playback or monitoring during recording operation.
- 9 MODE switch (AM-52 only: MONO/ STEREO)**
To select the playback mode. Normally set this switch to STEREO.
- 10 TAPE MONITOR indicator (AM-52 only: TAPE 1/TAPE 2)**
Tells you the TAPE MONITOR switch is engaged.
- 11 BALANCE control**
To adjust the left and right channel balance.
- 12 SUBSONIC switch (ON/ OFF)**
To reduce unwanted ultra low frequency disturbance (less than 15 Hz) such as rumble during record playback.
- 13 BASS and TREBLE Tone Controls**
To adjust the high note (treble) and low note (BASS) levels.
- 14 PHONES jack**
For headphone listening.
- 15 SPEAKER switch (SYSTEM A/SYSTEM B, ON/ OFF)**
To select the speaker system.

Protection circuit
When the Akai amplifier is turned on, no signal will be output to the speakers for several seconds. This is due to the protection circuit which prevents output of noise when the Akai amplifier is turned on.
The protection circuit also functions during playback to protect the speakers from overloading, and to protect the circuit from damages. When speakers with less than rated impedance are used, the protection circuit will short-circuit the + and - speaker cords. Therefore, should the sound be cut during playback:
1 Turn off the Akai amplifier.
2 Check for and correct the cause.
3 Turn on the Akai amplifier.

Let's Enjoy Music

Set the following controls before turning on the power of your amplifier.

- VOLUME control ——— Minimum (to 0)
- BALANCE control ——— Center (0)
- LOUDNESS switch ——— OFF ()
- MUTING switch ———  OFF
- SUBSONIC switch ———  OFF
- MODE switch ———  STEREO (AM-52)
- BASS and TREBLE tone controls ——— Center position
- SPEAKERS switches ——— Set either A or B ON () if using 1 system, or both ON if using 2 systems. Set both OFF () if using headphones.

For compact disc playback

① Depress the POWER switch to turn on the power.

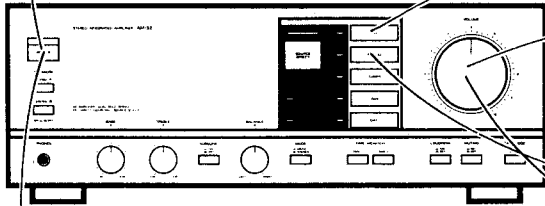

② Depress the CD button.

③ Play back a compact disc.

④ Adjust the VOLUME control to suit your taste.

① Depress the POWER switch to turn on the power.

② Depress the PHONO button.

③ Play back a record.

④ Adjust the VOLUME control to suit your taste.

For record playback

Listening to radio

① Depress the POWER switch to turn on the power.

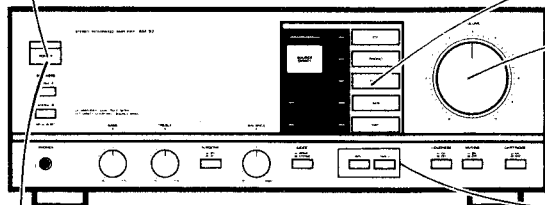

② Depress the TUNER selector.

③ Tune in a station you want to listen to.

④ Adjust the VOLUME control to suit your taste.

① Depress the POWER switch to turn on the power.

② Depress the TAPE MONITOR switch.

③ Play back a tape.

④ Adjust the VOLUME control to suit your taste.

For tape playback

- * After playing back a tape, turn off the TAPE MONITOR switch, by depressing the button again.
- * Before playing back a tape, make sure that the SOURCE DIRECT switch is turned off.

Let's Record

7 Basic recording

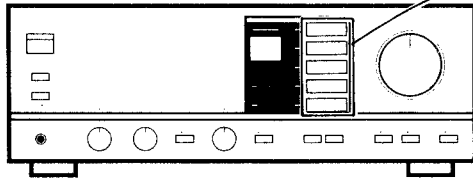

- The VOLUME, BALANCE, LOUDNESS, and BASS and TREBLE tone controls can be adjusted when recording.
- If the tape deck is a 3 head deck, (one which has independent heads for erasing, recording, and playback), the just-recorded signals can be monitored by depressing the TAPE MONITOR switch (TAPE 1 or TAPE 2 for AM-52). The playback sound of the input source can be adjusted with the VOLUME control of the amplifier, but it will have no effect on the recording volume level. To adjust the recording volume level, use the tape deck's REC LEVEL control.

- 1 Select the recording **source** with the proper Input select buttons.
To record from ...
 a compact disc → Depress the CD button
 a record → Depress the PHONO button
 the radio → Depress the TUNER button
 an auxiliary source → Depress the AUX button
 DAT tape → Depress the DAT button
- 2 Play back the source.
- 3 Prepare the tape deck or the DAT deck for recording.
 Begin recording.

For the AM-52 user

Do not depress both the TAPE 1 and TAPE 2 TAPE MONITOR switches at the same time during recording.

If you want to monitor during recording when the two decks are in the recording mode, turn one of the TAPE MONITOR switches on and turn the other one off.

Tape Dubbing

To make a copy of a prerecorded cassette tape:

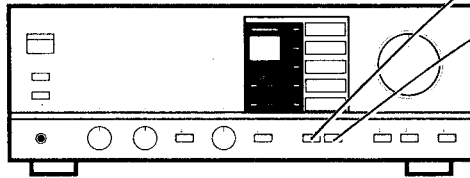

For the AM-52 user

- 1 Depress TAPE 1 of the TAPE MONITOR switch.
- 2 Depress TAPE 2 of the TAPE MONITOR switch so it is OFF, the indicator light will turn off.
- 3 Prepare the TAPE 1 deck for playback.
 Prepare the TAPE 2 deck for recording.
- 4 Begin recording.
 - Do not depress the TAPE 1 switch during tape dubbing. If depressed, tape dubbing will not be performed.
 - Tape dubbing from the TAPE 2 deck to the TAPE 1 deck cannot be done.

For the AM-32 user

For tape dubbing, connect a cassette deck for playback as follows:

Connection

Connect the LINE OUT jacks of the cassette deck to the AUX jacks of the amplifier with a connection cord.

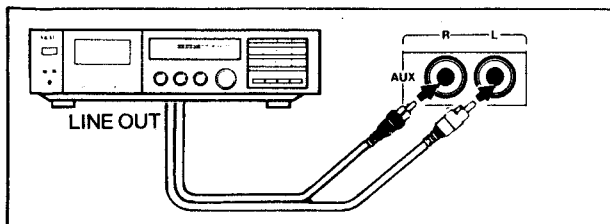

- 1 Depress the AUX button of the input select button.
- 2 Prepare the cassette deck connected to the AUX jacks for playback.
 Prepare the cassette deck connected to the TAPE jacks for recording.
- 3 Begin recording
 - If you want to monitor with the 3 head deck during tape dubbing, depress the TAPE MONITOR switch to on.
 After monitored, depress the TAPE MONITOR switch once again to turn off.

ADAPTOR jacks

To achieve more finely adjusted tone compensation, connect a separate graphic equalizer or audio processor to your Akai amplifier.

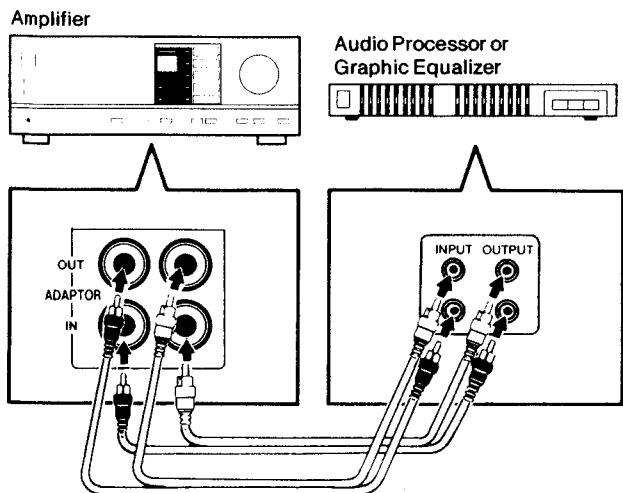

Remove the short pins from the amplifier's ADAPTOR jacks.

Connect the amplifier's ADAPTOR OUT jacks to the Audio Processor's or Graphic Equalizer's INPUT jacks.

Connect the amplifier's ADAPTOR IN jacks to the Audio Processor's or Graphic Equalizer's OUTPUT jacks.

- Refer to the operator's manual of your audio processor or graphic equalizer for further details.
- Set your Akai amplifier's built-in BASS and TREBLE tone controls to their center position when using an audio processor or graphic equalizer.

DAT jacks

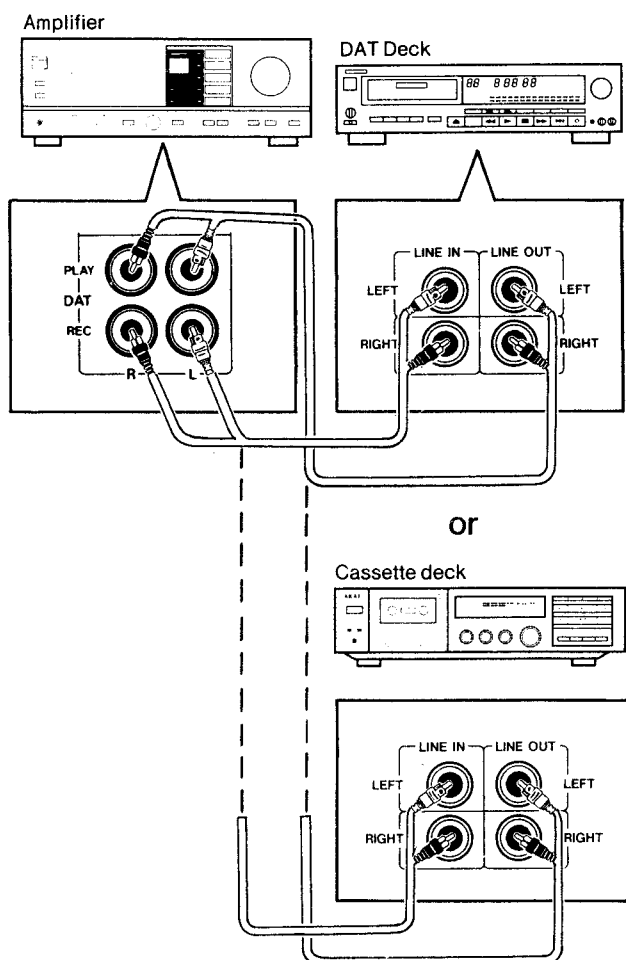

For recording and playback with a DAT deck.

Connect the amplifier's DAT REC jacks to the DAT deck's LINE IN jacks with a connection cord.

Connect the amplifier's DAT PLAY jacks to the DAT deck's LINE OUT jacks with a connection cord.

Note:

- DAT deck: Digital Audio Tape deck
- You can use a cassette deck instead of the DAT deck. Connect it to the DAT jacks of the amplifier.

During tape playback or tape dubbing operation

You can record from a compact disc, a record, the radio or an auxiliary source with a DAT deck during tape playback or tape dubbing operation.

- 1 Select a recording source with an input select button such as the CD, PHONO, TUNER or AUX buttons.
 - 2 Prepare for playback and prepare the DAT deck for recording.
 - 3 Begin recording.
- If you want to monitor during recording, depress the SOURCE DIRECT switch to turn it on. After you have finished monitoring, depress the SOURCE DIRECT switch once again to turn it off.

The parts of the Akai Amplifier

9

If you want to reduce the volume instantly during playback

Depress the MUTING switch to ON .

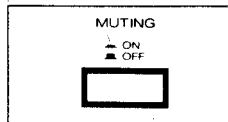

To resume the normal listening volume level
Depress the MUTING button once again to OFF .

For the best sound reproduction from a compact disc, record, the radio or an auxiliary source

Depress the SOURCE DIRECT switch to ON . The indicator will light.

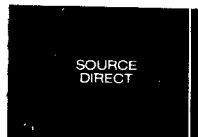

Note



When the SOURCE DIRECT switch is turned on, the BASS, TREBLE and BALANCE controls are ineffective. Tape playback can also not be performed when the switch is on but recording will operate.

Loudness compensation

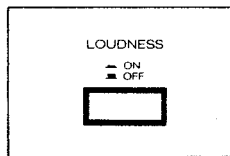
The human ear is less sensitive to low frequencies at low volume levels. If these frequencies are not boosted or compensated, the sound will seem unnatural. A more natural sound can be obtained by boosting the bass responses. This is called loudness compensation. When listening to music at low volume levels, depress the LOUDNESS switch on () for an instant boost of the bass.



Headphone use and SPEAKER switches

The SPEAKERS A and B buttons allow you to switch between the speakers connected to the A SPEAKERS terminals or the B SPEAKERS terminals on the rear panel of the Akai amplifier. If only one set of speakers is connected to the rear SPEAKERS terminals, simply set the other button to the OFF () position. **When listening through headphones, set both speaker buttons to their OFF () positions.**

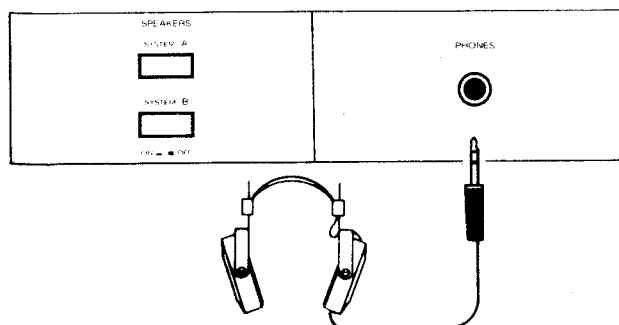

To adjust tone during playback

Use the BASS and TREBLE tone controls

To increase or decrease the bass

..... use the **BASS** control.

To increase or decrease the treble

..... use the **TREBLE** control.

During record playback

If your player system uses the MC (Moving Coil) type cartridge

Set the CARTRIDGE selector switch to MC .

Otherwise set this switch to MM .

Before setting the CARTRIDGE switch, read cartridge's instruction sheet.

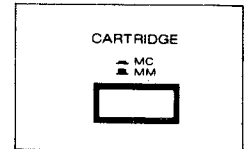



If the woofer cone vibrates during record playback

Set the SUBSONIC switch to ON .

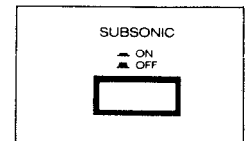
* Set the SUBSONIC switch to OFF  for other source playback.



MODE switch (AM-52 only)

If you want monaural sound playback, set the MODE switch to MONO . With the MODE switch in the off position, playback will be in stereo. When a normal sound VCR (monaural sound type) is connected to one of the AUX jacks (left or right); Set the MODE switch to MONO  during playback. The same sound will heard from the left and right channel speaker system.

The BALANCE control

Use the BALANCE control when you feel that there is a deficiency in the left and right balance due to the speaker placement.

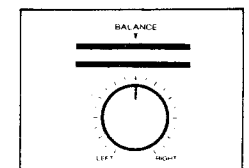

It is best to use a monaural source to test the balance. After setting the volume, tune in an AM station and turn the BALANCE control to left or right to boost the volume in the right or left channel respectively.

TAPE MONITOR switches (AM-52)

The TAPE MONITOR switches are independent of the other input select buttons. It is necessary to switch them OFF in order to listen to a different source.

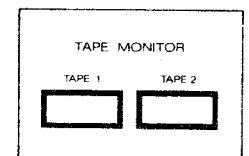

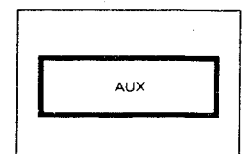

The AUX button

Depress the AUX button to play back a component which is connected to your amplifier's AUX jacks; such as a cassette deck for playback or a video disc player.



Problem? Let's check



No sound
<ul style="list-style-type: none">● Check to see if the power cord is connected securely to the household AC outlet.● The input select button corresponding to the music source you want to listen to is engaged. Press the appropriate input select button.● The TAPE MONITOR switches are depressed when you want to monitor an audio source.● The VOLUME control is set too low. Adjust the VOLUME control.● The SPEAKERS switch is turned OFF (). Turn ON () the A and/or B SPEAKERS switch.● Protection circuit is engaged. Check the speaker cord connections and the speaker impedance.● The ADAPTOR jack's short pins have been removed. Replace the short pins when an audio processor or a graphic equalizer is not connected to the Akai amplifier.

If there is little or no sound during playback
The MUTING switch is depressed. Turn down the VOLUME control if necessary, then turn off the MUTING switch by depressing it.

If the BASS, TREBLE and BALANCE controls do not work when adjusted or if tape playback cannot be heard when the TAPE MONITOR switch is depressed

The SOURCE DIRECT switch is depressed.
Turn off the SOURCE DIRECT switch by depressing it.

If distorted or little sound is heard during record playback

The CARTRIDGE switch is not set at the appropriate position ( MC or  MM) for the cartridge that you are using.
Confirm the type of cartridge with its instruction sheet or specifications of the turntable, then set the CARTRIDGE switch accordingly.

If during playback, you cannot hear the bass fully or the sound does not seem to be in stereo.

- Check the speaker connections.
Make sure that \oplus wires are connected to \oplus terminals and \ominus wires to \ominus terminals.

Should a problem persist, write down the model and serial numbers and all pertinent data regarding warranty coverage as well as a clear description of the existing trouble. Then contact your nearest authorized Akai Service Station.

The speaker system

Speaker placement

The playback characteristics of the speaker system(s) are greatly influenced by the placement and the room in which the speakers are used. For example, if the speaker system is placed near a hard wall, the bass will sound better but the treble might seem too strong. Play back some music without using the tone controls and move the speaker system around to find the best location. However, please keep the following in mind.

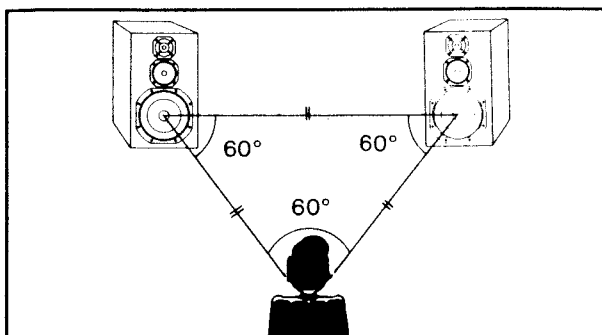

Place the speaker system:

- On a flat and solid surface which does not transmit too many vibrations.
- In a well ventilated, not very humid place.
- Away from direct sunlight and heat sources (stoves, etc.).
- Away from your turntable and TV.

To prevent damage to the speaker system.

- Do not raise the volume too high.
- Turn off the Akai amplifier when charging or connecting the player system's cartridge.
- Lower the volume when changing radio stations and when cueing or reviewing tapes.
- Do not touch the speakers' diaphragms

How to clean the speaker system (s)

- Clean the speaker system(s) with a soft, dry cloth.
- If they are very dirty, use a mild detergent.
- To protect the diaphragms (the vibrating parts), do not spray liquid cleaner directly on the speaker system. Always spray it on a cloth first.
- Never use alcohol, paint thinner, chemically treated cloth or use a spray-type insecticide near the speaker system, as this will damage the finish.

Specifications

11

Model	AM-52	8 ohms	4 ohms
Power Output by FTC			
(20 Hz—20 kHz)	70 W/0.03%	90 W/0.05%	
by DIN (1 kHz)	80 W/0.7%	120 W/0.7%	
Music Power	135 W	270 W	
Power Bandwidth	5 Hz to 50 kHz/0.06%		
Total Harmonic Distortion	0.005% (at Source Direct Mode)		
S/N (IHF-A)			
PHONO MM	84 dB		
PHONO MC	64 dB		
CD, Tuner, DAT	99 dB (at Source Direct Mode)		
Residual Noise	0.1 mV		
Cross Talk (10 kHz)	60 dB		
Channel Separation (10 kHz)	50 dB		
Damping Factor (1 kHz, 8 ohms)	50		
Required Speaker Impedance			
A or B	4 ohms to 16 ohms		
A and B	8 ohms to 16 ohms		
Input Sensitivity/Impedance			
PHONO MM	2.0 mV/47 kohms		
PHONO MC	0.2 mV/100 ohms		
CD, Tuner, Tape, DAT	150 mV/47 kohms		
Max. Input Level			
PHONO MM	160 mV		
PHONO MC	16 mV		
Output Level/Impedance			
Tape	150 mV/1 kohms		
Frequency Response			
PHONO (Deviation RIAA)	±0.5 dB		
CD, Tuner, DAT	5 Hz to 100 kHz (−3 dB) (at Source Direct Mode)		
Tone control			
Bass	±8.5 dB at 100 Hz		
Treble	±9.0 dB at 10 kHz		
Dimensions	425 (W) × 156 (H) × 377 (D) mm (16.7 × 6.1 × 14.8 inches)		
Weight	11.4 kg (25.2 lbs)		

* For improvement purposes, specifications and design are subject to change without notice.

Model	AM-32	8 ohms	4 ohms
Power Output by FTC			
(20 Hz—20 kHz)	50 W/0.03%	60 W/0.05%	
by DIN (1 kHz)	60 W/0.7%	80 W/0.7%	
Music Power	100 W	200 W	
Power Bandwidth	5 Hz to 50 kHz/0.06%		
Total Harmonic Distortion	0.005% (at Source Direct Mode)		
S/N (IHF-A)			
PHONO MM	82 dB		
PHONO MC	62 dB		
CD, Tuner, DAT	97 dB (at Source Direct Mode)		
Residual Noise	0.1 mV		
Cross Talk (10 kHz)	60 dB		
Channel Separation (10 kHz)	50 dB		
Damping Factor (1 kHz, 8 ohms)	50		
Required Speaker Impedance			
A or B	4 ohms to 16 ohms		
A and B	8 ohms to 16 ohms		
Input Sensitivity/Impedance			
PHONO MM	2.0 mV/47 kohms		
PHONO MC	0.2 mV/100 ohms		
CD, Tuner, Tape, DAT	150 mV/47 kohms		
Max. Input Level			
PHONO MM	160 mV		
PHONO MC	16 mV		
Output Level/Impedance			
Tape	150 mV/1 kohms		
Frequency Response			
PHONO (Deviation RIAA)	±0.5 dB		
CD, Tuner, DAT	5 Hz to 100 kHz (−3 dB) (at Source Direct Mode)		
Tone control			
Bass	±8.5 dB at 100 Hz		
Treble	±9.0 dB at 10 kHz		
Dimensions	425 (W) × 156 (H) × 377 (D) mm (16.7 × 6.1 × 14.8 inches)		
Weight	11.2 kg (24.7 lbs)		

* For improvement purposes, specifications and design are subject to change without notice.