

# AKAI

Creative At Heart

# AM-57

# AM-67

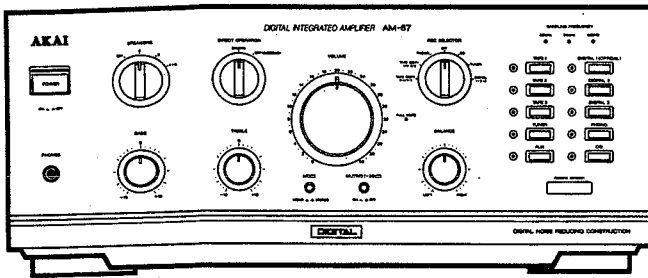

## DIGITAL INTEGRATED AMPLIFIER

### Operator's manual

To ensure optimum performance of this unit, please read this operator's manual thoroughly.  
This operator's manual applies equally to models AM-57 and AM-67 except where otherwise noted.  
The AM-67 model is used for the illustrations in this manual.

## AMPLIFICATEUR NUMERIQUE INTEGRE

### Manuel de l'utilisateur

Afin de garantir une performance optimale de cet appareil, lire attentivement ce manuel de l'utilisateur.  
Ce manuel de l'utilisateur s'applique également aux modèles AM-57 et AM-67 sauf indication contraire.  
Le modèle AM-67 est utilisé pour les illustrations dans ce manuel.

## DIGITAL-INTEGRIERTER VERSTÄRKER

### Bedienungsanleitung

Bitte lesen Sie sich diese Bedienungsanleitung aufmerksam durch, um eine optimale Leistung dieses Gerätes erzielen zu können.  
Diese Bedienungsanleitung gilt gleichermaßen für die Modelle AM-57 und AM-67, außer wo anders angegeben.  
In den Illustrationen dieser Bedienungsanleitung wurde das Modell AM-67 angewandt.

## DIGITALE GEINTEGREERDE VERSTERKER

### Gebruiksaanwijzing

Lees deze gebruiksaanwijzing in zijn geheel door teneinde optimaal gebruik te maken van de mogelijkheden die dit toestel biedt.  
Deze handleiding is eveneens van toepassing op modellen AM-57 en AM-67, behalve waar anders aangegeven.  
Het model AM-67 is gebruikt voor de illustraties in deze handleiding.

## AMPLIFICADOR DIGITAL INTEGRADO

### Manual de uso

A fin de garantizar un rendimiento óptimo de la unidad en todo momento, lea detenidamente este manual de instrucciones.  
Este manual de instrucciones es igualmente válido para los modelos AM-57 y AM-67, salvo cuando se indica lo contrario.  
El modelo AM-67 es utilizado para las ilustraciones en este manual de instrucciones.

English .....	Page	1 - 13
Français .....	Page	15 - 28
Deutsch .....	Seite	29 - 42
Nederlands .....	Pagina	43 - 56
Español .....	Página	57 - 70

# Precautions and table of contents

## WARNING

To prevent fire or shock hazard, do not expose this appliance to rain or moisture.

1-En

## Power requirements

Power requirements for electrical appliances differ from area to area. Please ensure that your unit meets the requirements in your area.

If in doubt consult a qualified electrician.  
220-230V, 50Hz.

2-En

This equipment conforms to NO.82/499/EEC, 87/308/EEC standard.

3A-En

CONFORME AL D.M. 13 APRILE 1989 DIRETTIVA CEE/87/308.

3B-It

## Make Your Contribution to Protect the Environment

Used batteries with the ISO symbol for recycling as well as small accumulators (rechargeable batteries), mini-batteries (cells) and starter batteries should not be thrown into the garbage can. Please leave them at an appropriate depot. All other household batteries can be thrown out with the household waste.



29-En

## Table of contents

Basic connections .....	3-4
Digital component connections .....	5
Controls .....	6
Remote control .....	7
Source playback .....	8
Operation details .....	9-10
Recording .....	11
Troubleshooting .....	12
Specifications .....	13

## What you should know to protect yourself

- Never touch the power cord's plug with wet hands.
- Always pull the power cord out by its plug, never by its cord.
- Only let a qualified professional repair or reassemble the amplifier. An inexperienced person might touch the internal parts and receive a serious shock.
- Never put anything, especially metal into the amplifier.

## Protect the amplifier too

- Use a household AC power source only. Never use a DC power source.
- If water is spilled on the amplifier, disconnect it and call your dealer.
- Make sure that the amplifier is well ventilated and away from direct sunlight.
- To avoid damage to the internal circuits and the external surface, keep the amplifier away from heat (stoves, etc.).
- Avoid using aerosol sprays near the amplifier as this could damage the finish or cause sudden ignition of the spray.
- To avoid damaging the finish, never use paint thinner or other similar chemicals to clean the amplifier.
- Place the amplifier on a flat and solid surface.
- If you do not plan to use the amplifier for a long period of time, disconnect the power cord.

# Basic connections

## Before connecting

- Turn off the power of all components before making connections.
- Connect the power cord last.
- Make sure that you connect the white pin-plugs to the left (L-white) terminals and the red pin-plugs to the right (R-red) terminals.
- Connect everything securely. Loose connections can lead to distortion.
- To prevent damage to the cords, connect and disconnect by holding the plug, not the cord.
- If your turntable is equipped with an earth wire, connect it securely to the amplifier's  $\perp$  terminal.

## Speaker connection

### Before connecting

- Check the impedance of your speakers.  
**When using one pair of speakers:**  
Connect speakers with an impedance of 4 to 16 ohms.  
**When using two pairs of speakers at the same time:**  
Connect speakers with an impedance of 8 to 16 ohms.  
The amplifier's red speaker terminals are the  $\oplus$  (positive) terminals and the black terminals are the  $\ominus$  (negative) terminals.
- The  $\oplus$  side of the speaker cable is marked to make it distinguishable from the  $\ominus$  side of the cable. Connect this marked side to the red  $\oplus$  terminal and the unmarked side to the black terminal.
- Prepare the speaker cords for connection by stripping off approximately 1 cm or less (no more as this could cause a short circuit) of the outer insulation.

### How to connect

- 1 Twist the wires together tightly.
- 2 Turn the terminal cap counter-clockwise to loosen it.  
The speaker terminal caps can not be fully removed from the base.
- 3 Insert the wire into the terminal fully and turn the terminal cap clock-wise to securely connect it.

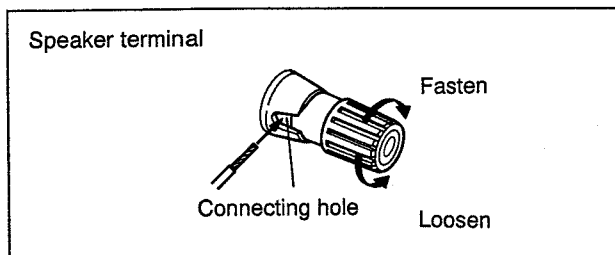

## Speaker placement

The playback characteristics of the speakers are greatly influenced by the placement and the room in which the speakers are used. To find the best location for the speakers play back some music without using the tone controls and move the speakers around. However please keep the following in mind:

- Place the speakers on a flat, solid surface which is free of vibration.
- Place the speakers in an area that is well ventilated. Do not place the speakers in a humid place.
- Keep the speakers away from direct sunlight and heat sources (stoves, etc.).
- Keep the speakers away from the turntable.

### To prevent damage to the speakers:

- Do not raise the volume excessively.
- Turn off the amplifier when connecting or disconnecting.
- Do not touch the speaker's diaphragms.

### Note:

- If the speakers are placed too close to the TV the magnetic flux from the speakers will cause the TV screen to turn slightly red or pink. To avoid this the speakers should be placed a little distance from the TV.

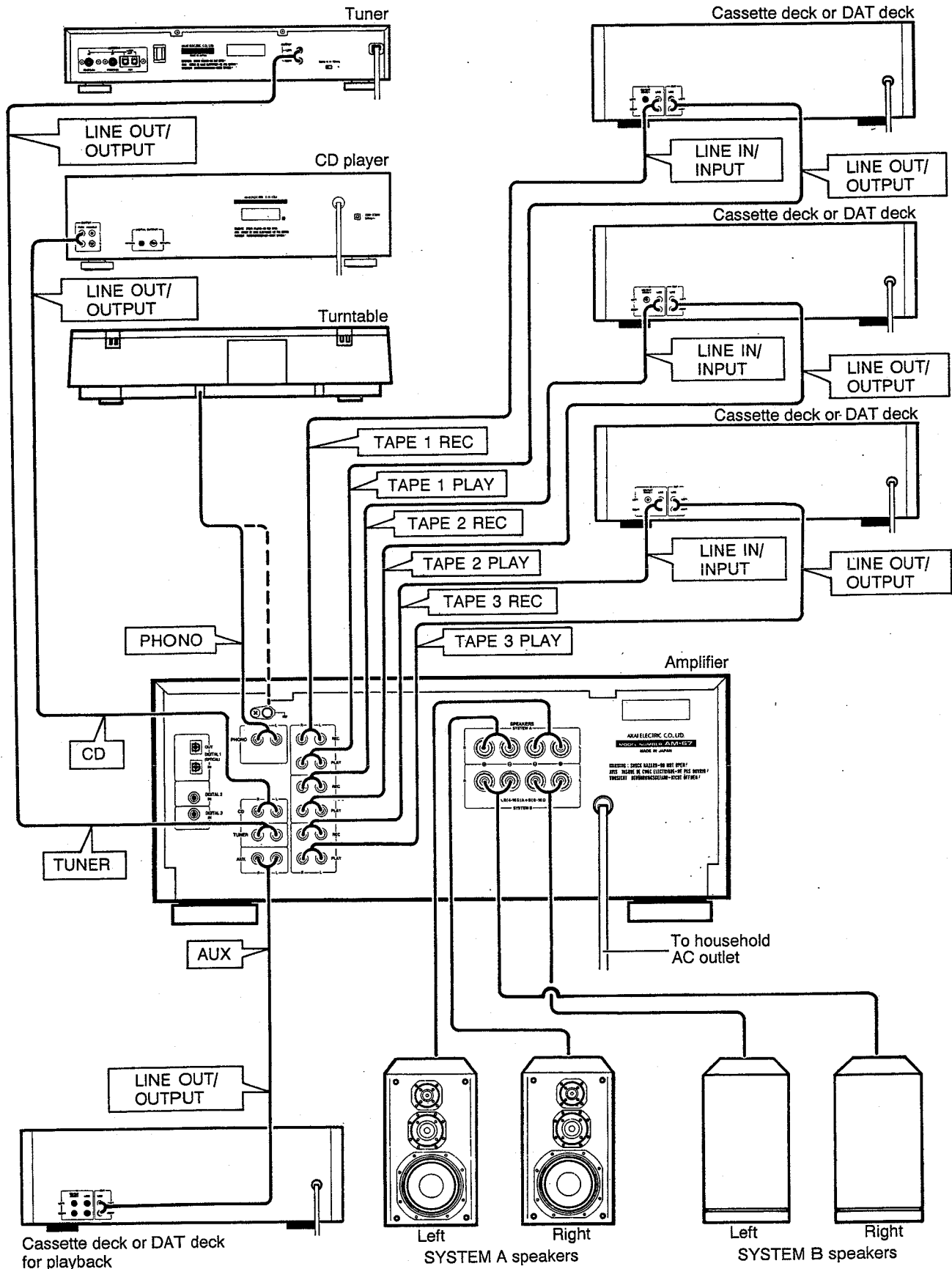

# Digital component connections (for AM-67 model only)

## Before proceeding

- Turn off the power of all components before making connections.
- When connecting components to the DIGITAL 2 and 3 IN terminals, use digital connection cords available from your audio dealer.
- If your DAT deck is equipped with optical input and output terminals, connect it to the DIGITAL 1 (OPTICAL) IN and OUT terminals of the amplifier using optical fibre cables.
- Always replace the terminal caps of the DIGITAL 1 (OPTICAL) IN and OUT terminals when a component is not connected to them.
- If your CD player is equipped with both an optical terminal and analog output terminals, we recommend that connection only be made to the optical terminal for best sound reproduction.
- The digital audio signal is a composite signal made up of the left and right channel signals. For this reason, separate left and right INPUT and OUTPUT terminals are not necessary.

## DIGITAL 1 (OPTICAL) IN/OUT terminals (AM-67 model only)

These terminals are for connection of CD players or DAT decks equipped with optical terminals.

### Note:

- When you are not using the DIGITAL 1 (OPTICAL) IN/OUT terminals do not remove the terminal caps.

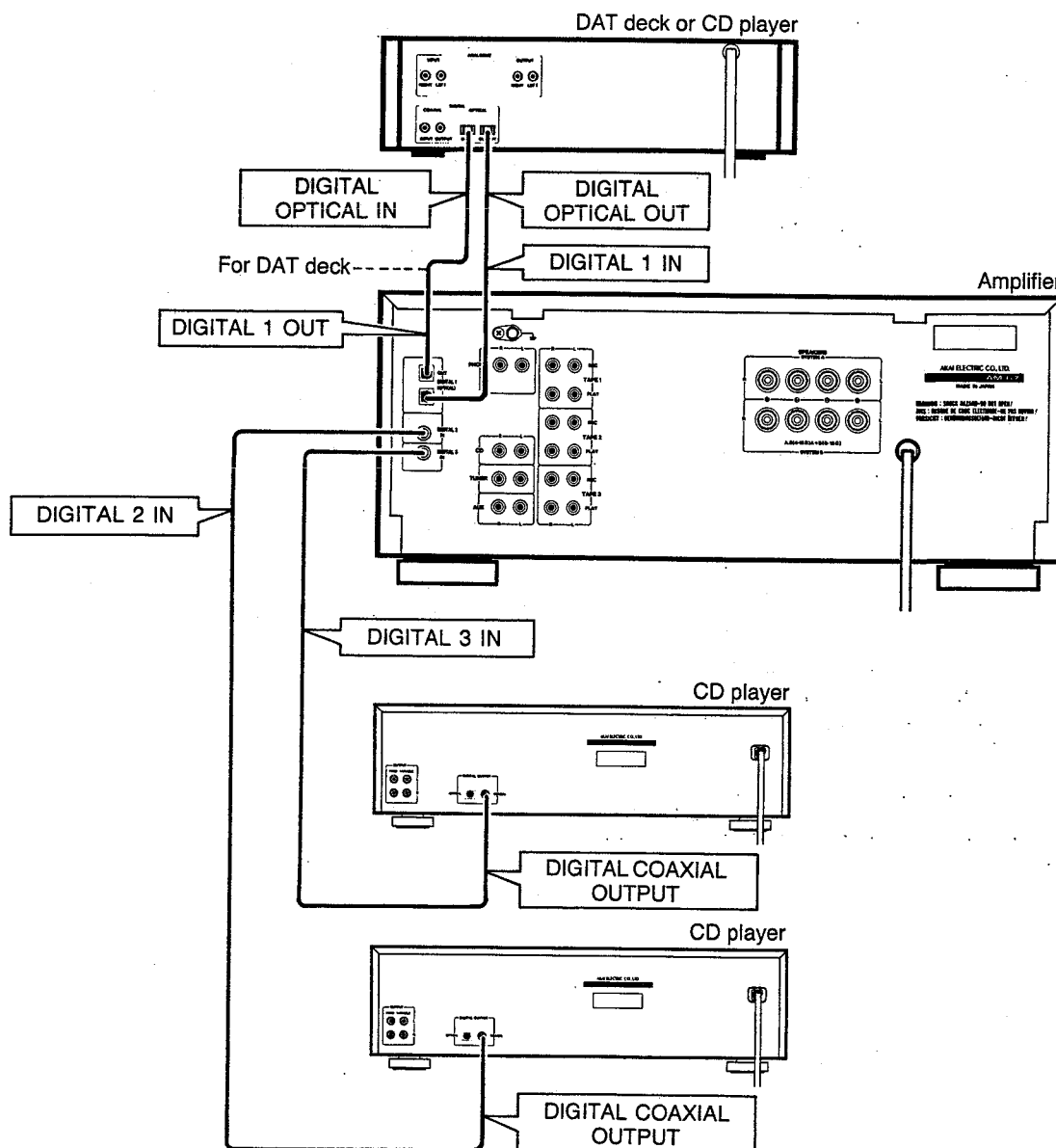

# Controls

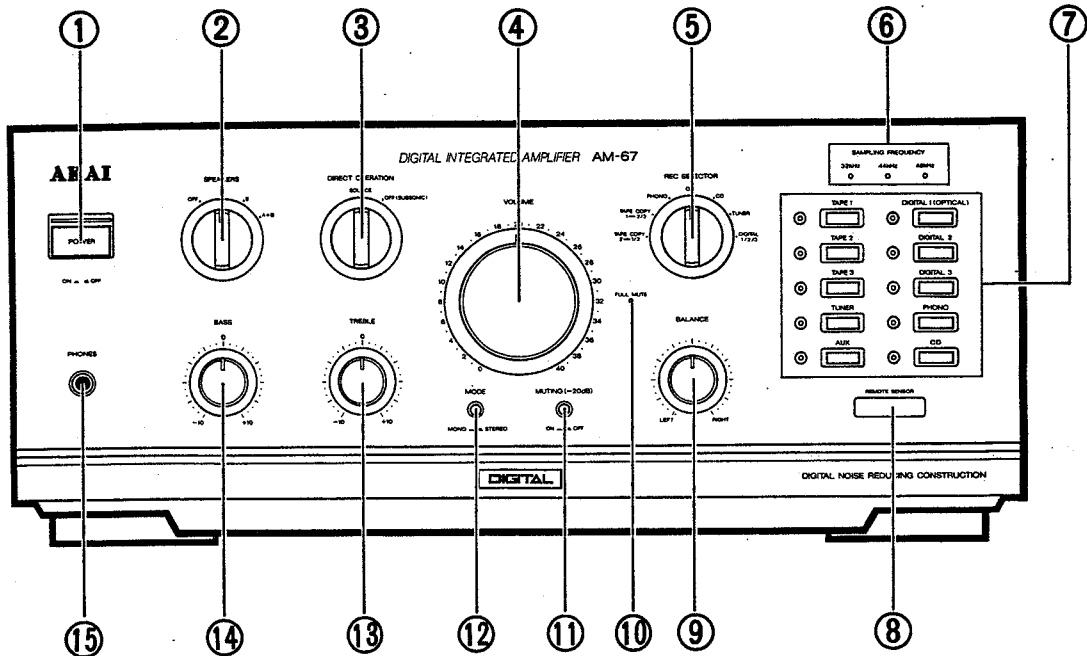

① **POWER ON**  /  **OFF** button and indicator

② **SPEAKERS** switch (OFF/A/B/A+B)  
To select the speakers or to cancel audio output from the speakers.

③ **DIRECT OPERATION** switch (SOURCE/OFF (SUB-SONIC))  
To select the playback operation mode.

④ **VOLUME** control  
To adjust the volume level. The 40 position is the maximum volume output of the amplifier.

⑤ **REC SELECTOR** switch  
(TAPE COPY 2 → 1/3/TAPE COPY 1 → 2/3/PHONO/OFF/CD/TUNER/DIGITAL 1/2/3 (AM-67 model)/AUX (AM-57 model))  
To select the playback source for recording.

⑥ **SAMPLING FREQUENCY** indicators  
(32kHz/44kHz/48kHz) (AM-67 model only)  
Light to indicate the sampling frequency of the digital source being played back.

⑦ **INPUT SELECTOR** buttons and indicators  
(TAPE 1/TAPE 2/TAPE 3/TUNER/PHONO/AUX/CD)  
(DIGITAL 1 (OPTICAL)/DIGITAL 2/DIGITAL 3 (AM-67 model only))

⑧ **REMOTE SENSOR** window

⑨ **BALANCE** control (LEFT/RIGHT)  
To adjust the left and right channel balance. Normally set to the "Centre" position.

⑩ **FULL MUTE** indicator  
Lights when the full mute mode is engaged.

⑪ **MUTING (-20dB) ON**  /  **OFF** button.  
To reduce volume instantly during playback.

⑫ **MODE MONO**  /  **STEREO** button.  
To select between the stereo and monaural playback mode.

⑬ **TREBLE** control  
To adjust the high note (treble) level.  
When set to "0", the control is ineffective.

⑭ **BASS** control  
To adjust the low note (bass) level.  
When set to "0", the control is ineffective.

⑮ **PHONES** jack  
For headphone connection.

# Remote control

The remote control can be used to conveniently operate the amplifier from a distance.

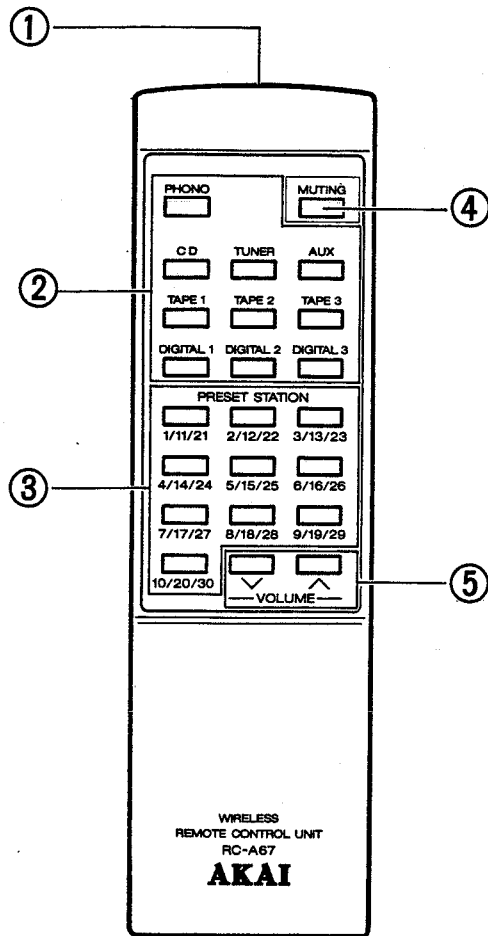

- 1 **Transmitting window**
- 2 **Input selector buttons**  
PHONO, CD, TUNER, AUX, TAPE 1, TAPE 2, TAPE 3  
DIGITAL 1, DIGITAL 2, DIGITAL 3 (for AM-67 model)
- 3 **PRESET STATION buttons**  
Used to select preset stations on optional AT-57/L tuner. Each button can be used to select 3 different preset stations. Station selection is cyclic (1 → 11 → 21 → 1 for example). Press the button that holds the desired station repeatedly until the station is selected.
- 4 **MUTING (full mute) button**
- 5 **VOLUME ^ / ∨ buttons**

## Operation

Point the remote control at the amplifier's REMOTE SENSOR window and press the desired operation button. If the remote control will only operate from a short distance or narrow angle, this indicates that the batteries are weak and need to be replaced.

## How to load the batteries

- 1 Slide the battery compartment cover in the direction of the arrow and remove it.
- 2 Load the batteries according to the polarity guides on the remote control unit.
- 3 Replace the battery compartment cover.

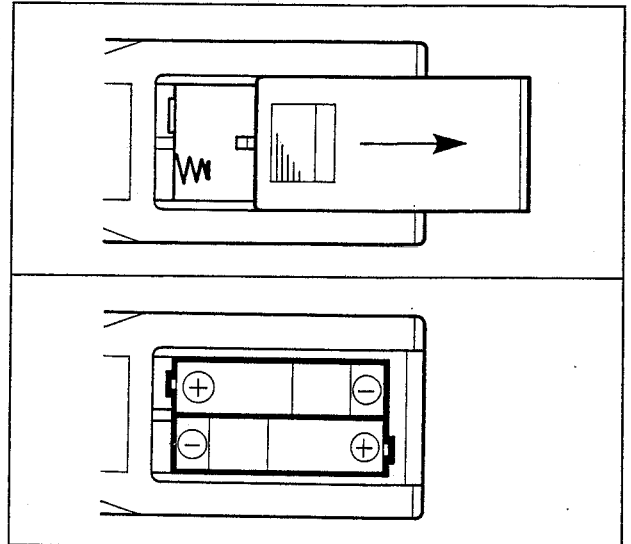

## Cautionary notes

### On the remote control

- Avoid dropping the remote control or getting it wet.
- Avoid exposing the remote control to direct sunlight or strong light as this may cause malfunction.
- Keep the remote control away from appliances that generate electrical noise (TV sets, micro-wave ovens, etc.).
- When replacing the batteries, clean all the remote control and battery terminals with a dry cloth.
- Avoid operating the remote control near fluorescent lights as this may cause malfunction.

### On the batteries

- When you do not plan to use the remote control for a long period of time, remove the batteries.
- Read the cautions printed on the batteries before inserting them.
- When replacing the batteries, replace them all at the same time. Do not mix old batteries with new ones.

# Source playback

## Before proceeding

- Set the VOLUME control to 0.
  - Set the MUTING switch to **OFF**.
  - Set the REC SELECTOR switch to OFF.
  - Turn on the power of all components.
- After the amplifier's power has been turned on, the protection circuit will be engaged for a few seconds. The amplifier can not be operated during this time.

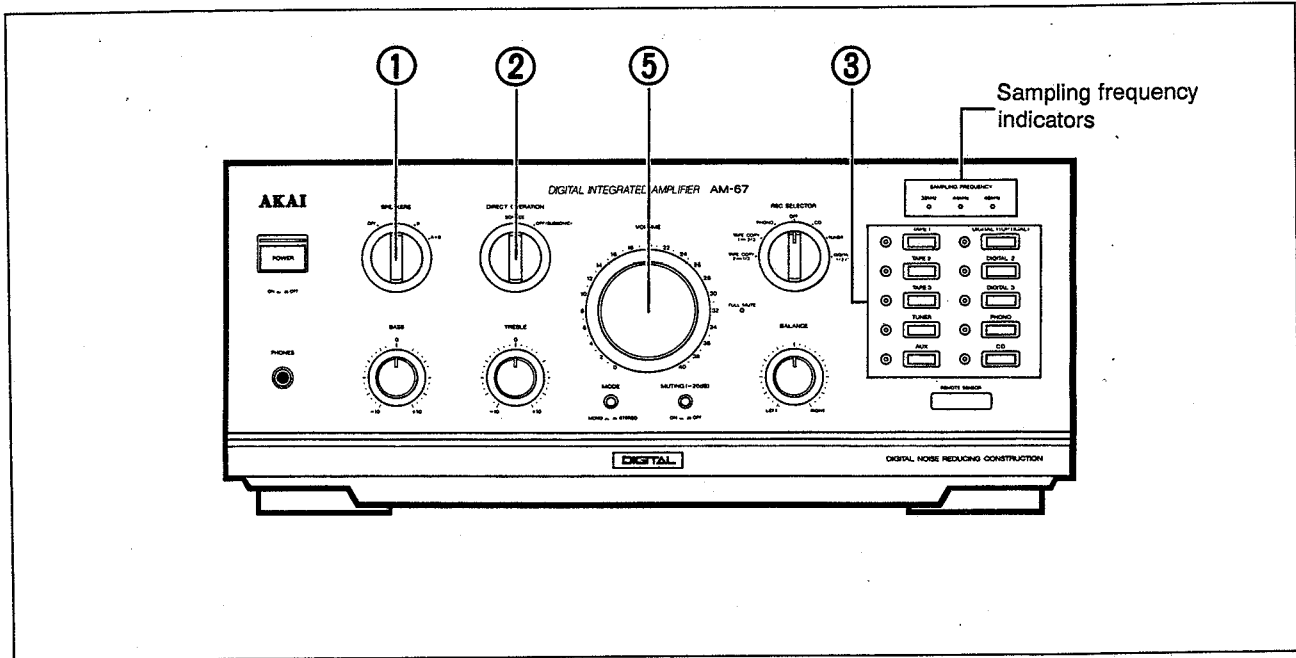

- 1 Set the SPEAKERS switch to the desired position as follows.

If you have connected speakers to the A terminals:  
Set the switch to the A position.  
If you have connected speakers to the B terminals:  
Set the switch to the B position.  
If you have connected speakers to both the A and B terminals:  
Set the switch to the A+B position.

- 2 Set the DIRECT OPERATION switch to SOURCE or OFF (SUBSONIC).
- 3 Select the playback source with the input selector buttons as follows:

**For broadcast reception:**  
Press the TUNER button.

**For record playback:**  
Press the PHONO button.

**For CD playback:**  
Press the CD button.

**For auxiliary source playback:**  
Press the AUX button.

**For playback of a cassette deck or DAT deck connected to the TAPE 1, 2 or 3 terminals:**  
Press the TAPE 1, 2 or 3 button depending on where the component is connected.

**For digital source playback (AM-67 model only):**  
Press the DIGITAL 1 (OPTICAL), DIGITAL 2 or DIGITAL 3 button depending on which digital terminal the component is connected to.

- 4 Play back the selected source.

- 5 Adjust the playback volume with the VOLUME control.

**After playback is finished:**

After turning the volume down turn the power off by pressing the POWER button.

## Sampling frequency indicators (AM-67 model only)

The sampling frequency indicators light up during digital source playback to indicate the source's sampling frequency.

The sampling frequency is an important frequency necessary for digital to analog signal conversion during playback. The standard sampling frequencies are 48kHz, 44.1kHz and 32kHz.

\* The 44kHz indicator will light up during 44.1kHz sampling frequency source playback.



# Operation details

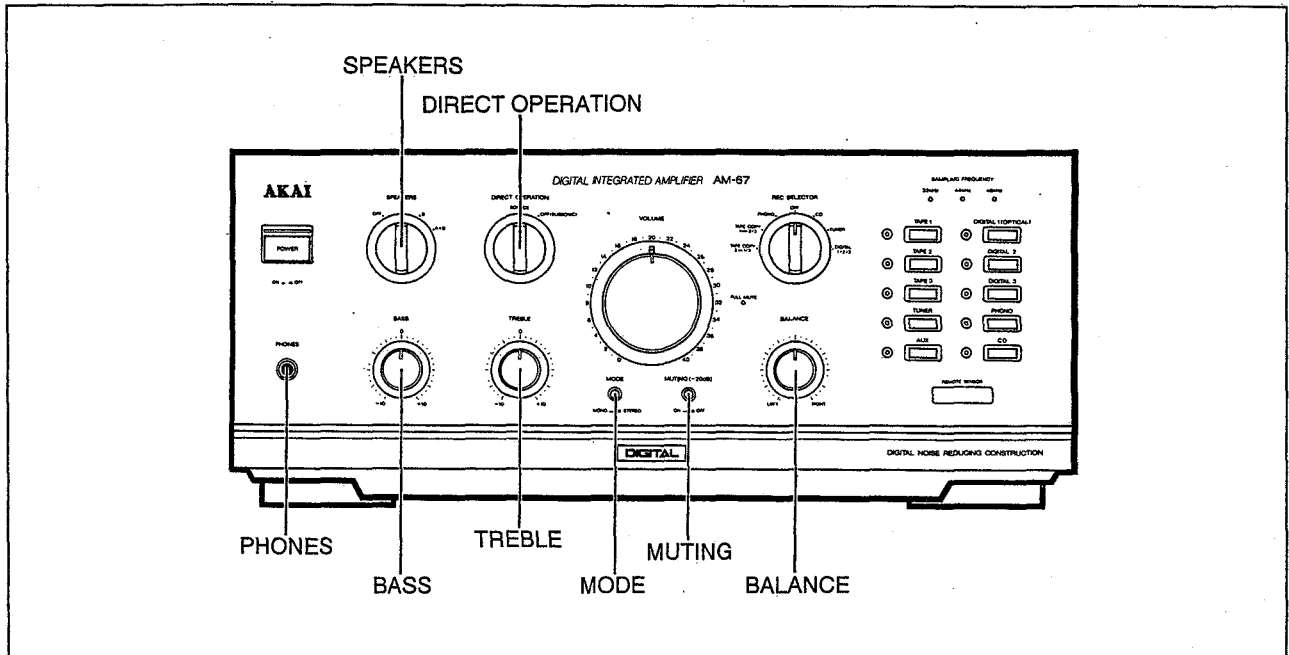

## DIRECT OPERATION switch

The DIRECT OPERATION switch is used to help improve sound quality by selecting the shortest circuit route through the amplifier that the playback signal has to travel.

### When set to SOURCE:

The subsonic filter, tone control circuit and balance control circuits are by-passed.

### When set to OFF (SUBSONIC):

The playback signal is routed through the subsonic filter, tone control circuit and balance control circuits. During record playback this position can be used to reduce ultra low frequency noise, rumble, hum etc. (indicated by woofer vibration during playback).

### Note:

- The subsonic filter removes low frequency signals (18Hz or lower) that are present in the playback signals.

## Treble and bass tone adjustment

- 1 Set the DIRECT OPERATION switch to OFF (SUBSONIC).
- 2 Use the BASS and TREBLE controls as follows:

### Bass adjustment

- To increase the level:**  
Turn the BASS control toward + 10.
- To decrease the level:**  
Turn the BASS control toward - 10.
- To defeat the control:**  
Set the control to 0.

### Treble adjustment

- To increase the level:**  
Turn the TREBLE control toward + 10.
- To decrease the level:**  
Turn the TREBLE control toward - 10.
- To defeat the control:**  
Set the control to 0.

## Left/right channel volume balance adjustment

- 1 Set the DIRECT OPERATION switch to OFF (SUBSONIC).
- 2 Use the BALANCE control as follows:

- To decrease the right channel volume:**  
Turn the BALANCE control to the LEFT.
- To increase the left channel volume:**  
Turn the BALANCE control to the RIGHT.

## Listening with headphones

- 1 Set the **SPEAKERS** switch to **OFF** .
- 2 Connect the headphones to the **PHONES** jack.
- 3 Adjust the volume with the **VOLUME** control.

### Caution:

- Do not listen for long periods of time at high volume levels as this may damage your hearing.
- When connecting a pair of headphones during playback, turn the volume down first.

## Volume mute

The muting system can be used to instantly reduce playback volume. There are two muting systems to choose from; partial mute, engaged with the amplifier's **MUTING** (-20dB) button and full mute, engaged with the remote control's **MUTING** button. During partial mute, volume will be reduced by -20dB. During full mute the volume will be cut completely.

### To mute the volume:

- Press the amplifier's **MUTING** button to the **ON**  position, or press the remote control's **MUTING** button.



### To resume the normal volume level:

- Press the amplifier or remote control's **MUTING** button again.

### Note:

- When the full mute mode is engaged with the remote control's **MUTING** button, the amplifier's **FULL MUTE** indicator will light.

## Stereo/monaural sound selection

- 1 Set the **DIRECT OPERATION** switch to **OFF (SUB-SONIC)**.
- 2 Press the **MODE** button as follows:
  - For monaural selection:**  
Press the **MODE** button to the **MONO**  position.
  - For stereo selection:**  
Press the **MODE** button to the **STEREO**  position.

## Protection circuit

This amplifier includes a built-in protection circuit that is activated to protect the speakers from noise damage when the amplifier's power is turned on. The protection circuit also functions during playback to protect the speakers from overloading and to protect the circuits from damage. When the protection circuit is engaged, the output signal will be cut automatically.

### Should the sound be cut during playback:

- 1 Turn the amplifier off.
- 2 Check for and correct the cause.
- 3 Turn the amplifier back on.

# Recording

## Before proceeding

- Turn on the power of all components.
- If using a DAT deck for recording, set it for analog recording.
- **When connecting components for tape dubbing:**  
The TAPE 1 and 2 terminals are for connection of the source deck or recording deck.  
The TAPE 3 terminals are for connection of the recording deck only.

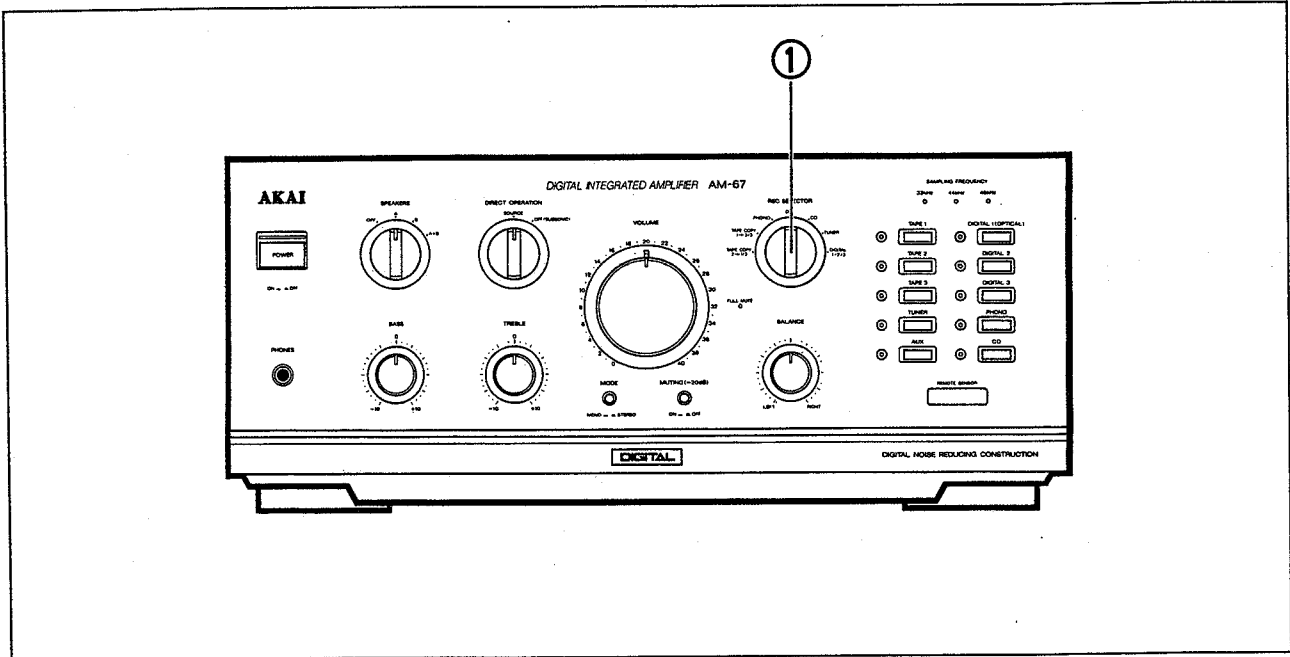

### 1 Select the recording source with the REC SELECTOR switch as follows:

#### For broadcast recording:

Set to TUNER.

#### For record disc recording:

Set to PHONO.

#### For CD recording:

Set to CD.

#### For digital source recording (AM-67 model only):

Set to DIGITAL 1/2/3 and press the DIGITAL 1 (OPTICAL), DIGITAL 2 or DIGITAL 3 input selector button, depending on which digital terminal the source component is connected to.

#### For tape dubbing:

Set to TAPE COPY 1 → 2/3 when recording from a cassette deck or DAT deck connected to the TAPE 1 terminals.

#### For tape dubbing:

Set to TAPE COPY 2 → 1/3 when recording from a cassette deck or DAT deck connected to the TAPE 2 terminals.

### 2 After adjusting the recording level of the cassette deck or DAT deck, start recording.

#### After recording is finished:

Set the REC SELECTOR switch to OFF and turn off the power.

## Monitoring the recording

To monitor the sound of the source being recorded, select the source with the input selector buttons.

If the tape deck you are using to record on has 3 heads, you can monitor the actual sound that is being recorded by pressing the input selector button that corresponds to the recording deck you wish to monitor.

## Listening to another source during recording

If you wish to listen to another source during recording, simply select that source with the input selector buttons. Recording will not be interrupted.





To adjust the sound of the selected source (using the VOLUME, BALANCE, BASS, TREBLE, MODE or MUTING controls), set the DIRECT OPERATION switch to OFF (SUBSONIC) **before recording**. Signals being recorded will not be affected by adjustments.

#### Note:

- During recording do not change the position of the REC SELECTOR switch as this will interfere with recording.
- **For AM-67 model:** During digital source recording, do not change the DIGITAL 1 (OPTICAL), 2 or 3 input selector button setting as this will interfere with recording.

# Troubleshooting

Should you have any problems during the operation of this amplifier, please check that all the controls are set to their proper positions and that all the connections are correct (refer to this manual for the proper procedures). If a problem persists refer to the advice below. If the problem cannot be corrected with the instructions below, write down the model and serial numbers and all pertinent data regarding warranty coverage, as well as a clear description of the problem and contact your nearest AKAI service centre.

Problem	Check point
No power. No sound.	<ul style="list-style-type: none"> <li>• Amplifier connections are not correct. Check the amplifier connections.</li> <li>• SPEAKERS switch is set to the wrong position. Set the switch to the correct position.</li> <li>• VOLUME control is set to 0. Set the VOLUME control to the desired position.</li> <li>• The correct input selector button is not pressed. Press the correct button.</li> </ul>
No sound after the power is turned on.	<ul style="list-style-type: none"> <li>• The protection system is engaged. Wait a few seconds.</li> </ul>
No sound after the power is turned on (even after playback volume adjustment).	<ul style="list-style-type: none"> <li>• The protection system is engaged. Stop playback as soon as possible, turn off the power, and then check the speaker cord connections. Connect a speaker system with an impedance of over 8 ohms or set the SPEAKERS switch to OFF.</li> </ul>
VOLUME setting indicates a higher volume level than can be heard.	<ul style="list-style-type: none"> <li>• The MUTING switch is set to ON . Set the switch to OFF .</li> </ul>
Humming noise is heard during record playback.	<ul style="list-style-type: none"> <li>• The turntable's ground wire (if included) is not connected or connection cords are not securely connected. Connect the ground wire to the  terminal and make sure that the connection cords are connected securely.</li> </ul>
Bass or stereo sound is not reproduced fully.	<ul style="list-style-type: none"> <li>• Speakers are not connected correctly. Check the polarity of the connections.</li> </ul>
Deck will not play back.	<ul style="list-style-type: none"> <li>• The correct input selector button is not pressed. Press the correct button.</li> </ul>
Digital source playback can not be performed.	<ul style="list-style-type: none"> <li>• Connections are not correct or the digital terminals are not used for connection. Check the connections and change them if necessary. Connections should be made with digital connection cords available from your audio dealer.</li> <li>• The correct input selector button (DIGITAL 1 (OPTICAL), 2 or 3) has not been pressed.</li> <li>• Press the appropriate button.</li> </ul>
BASS, TREBLE, BALANCE or MODE controls are not effective.	<ul style="list-style-type: none"> <li>• The DIRECT OPERATION switch is set to SOURCE. Set it to OFF (SUBSONIC).</li> </ul>
Playback is monaural.	<ul style="list-style-type: none"> <li>• The MODE button is set to MONO . Set it to STEREO .</li> </ul>
The woofer's diaphragm vibrates slowly during playback.	<ul style="list-style-type: none"> <li>• A warped record is being played back. Set the DIRECT OPERATION switch to the OFF (SUBSONIC) position to remove subsonic noise.</li> </ul>
Recording can not be performed.	<ul style="list-style-type: none"> <li>• Decks are not properly connected. Check the connections.</li> <li>• The REC SELECTOR switch is not set to the appropriate position. Set it to the proper position.</li> </ul>
Digital recording can not be performed.	<ul style="list-style-type: none"> <li>• Connections are not proper or the digital input and output terminals are not being used. Check the connections and change them if necessary. Connections should be made with digital connection cords available from your audio dealer.</li> <li>• The DAT deck is not in the digital recording mode. Set the deck to the digital recording mode.</li> <li>• The digital source is protected from recording. Play back the source in the analog mode for recording.</li> <li>• The DIGITAL 1 (OPTICAL), 2 or 3 input selector button has not been pressed. Press the appropriate button.</li> </ul>
Tape dubbing can not be performed.	<ul style="list-style-type: none"> <li>• The REC SELECTOR switch is not set to the appropriate position. Set the switch to the appropriate position.</li> </ul>

# Specifications

Power output (at AC 230 V)	
AM-67 .....	200W + 200W (DIN, 4 ohms, 1kHz, 1%) 110W + 110W (FTC, 8 ohms, 20Hz to 20kHz, 0.05%)
AM-57 .....	170W + 170W (DIN, 4 ohms 1kHz, 1%) 100W + 100W (FTC, 8 ohms, 20Hz to 20kHz, 0.05%)
Power band width .....	5Hz to 60kHz/0.1%
Total harmonic distortion ....	0.005% (1kHz, 8 ohms)
Frequency response .....	5Hz to 100kHz (+0dB, -3dB)
Tone control	
Bass .....	±8dB (100Hz)
Treble .....	±8dB (10kHz)
Input sensitivity/impedance	
Phono (MM) .....	2.0mV/47k ohms
Tuner/CD/Tape .....	150mV/47k ohms
Maximum input level	
Phono .....	150mV
Output level	
Tape rec out .....	150mV
Damping factor .....	45 (1kHz, 8 ohms)
Residual noise .....	0.1mV (A-filter)
S/N	
Phono (MM) .....	86dB (IHF-A)
Tuner/CD/Tape .....	102dB (IHF-A)
Audio mute .....	-20dB
Subsonic filter .....	10Hz (-12dB/oct)
Channel separation .....	75dB (1kHz)/55dB (10kHz)
Cross talk	
Phono .....	75dB (1kHz, 5.0mV input level)
Tuner/CD/Tape .....	85dB (1 kHz, 500mV input level)
Required speaker impedance	
A or B .....	4 to 16 ohms
A and B .....	8 to 16 ohms
Power requirement .....	220-230V, 50Hz
Power consumption	
AM-67 .....	330W
AM-57 .....	280W
Dimensions .....	425(W) × 177(H) × 401(D)mm
Weight	
AM-67 .....	14.8kg
AM-57 .....	13.3kg
Digital section (AM-67 only)	
Sampling frequency .....	32kHz/44.1kHz/48kHz
Digital filter .....	18 bit, 8 times over sampling
D/A converter .....	Interpolative one bit dual
Digital input level	
Coaxial .....	0.5Vp-p/75 ohms
Optical .....	-14 to -23dBm
Frequency response .....	5Hz to 20kHz (±0.3dB)
Dynamic range .....	96dB
Total harmonic distortion ....	0.002%

\* For improvement purposes, specifications and design are subject to change without notice.

# Memo

---