

# *MiniDisc Deck*

---

Operating Instructions



*MDS-JE500*

## WARNING

To prevent fire or shock hazard, do not expose the unit to rain or moisture. To avoid electrical shock, do not open the cabinet. Refer servicing to qualified personnel only.

The laser component in this product is capable of emitting radiation exceeding the limit for Class 1.

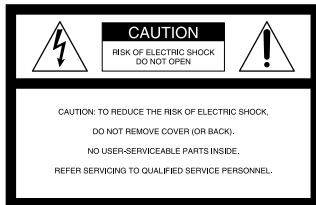

This symbol is intended to alert the user to the presence of uninsulated "dangerous voltage" within the product's enclosure that may be of sufficient magnitude to constitute a risk of electric shock to persons.



This symbol is intended to alert the user to the presence of important operating and maintenance (servicing) instructions in the literature accompanying the appliance.

### INFORMATION

This equipment has been tested and found to comply with the limits for a Class B digital device, pursuant to Part 15 of the FCC Rules. These limits are designed to provide reasonable protection against harmful interference in a residential installation. This equipment generates, uses, and can radiate radio frequency energy and, if not installed and used in accordance with the instructions, may cause harmful interference to radio communications.

However, there is no guarantee that interference will not occur in a particular installation. If this equipment does cause harmful interference to radio or television reception, which can be determined by turning the equipment off and on, the user is encouraged to try to correct the interference by one or more of the following measures:

- Reorient or relocate the receiving antenna.
- Increase the separation between the equipment and receiver.
- Connect the equipment into an outlet on a circuit different from that to which the receiver is connected.
- Consult the dealer or an experienced radio/TV technician for help.

### CAUTION

You are cautioned that any changes or modification not expressly approved in this manual could void your authority to operate this equipment.

### Owner's Record

The model and serial numbers are located on the rear of the unit. Record the serial number in the space provided below. Refer to them whenever you call upon your Sony dealer regarding this product.

Model No. MDS-JE500

Serial No. \_\_\_\_\_

IN NO EVENT SHALL SELLER BE LIABLE FOR ANY DIRECT, INCIDENTAL OR CONSEQUENTIAL DAMAGES OF ANY NATURE, OR LOSSES OR EXPENSES RESULTING FROM ANY DEFECTIVE PRODUCT OR THE USE OF ANY PRODUCT.

## Precautions

### On safety

- The use of optical instruments with this product will increase eye hazard.
- Should any solid object or liquid fall into the cabinet, unplug the deck and have it checked by qualified personnel before operating it any further.

### On power sources

- Before operating the deck, check that the operating voltage of the deck is identical with your local power supply. The operating voltage is indicated on the nameplate at the rear of the deck.
- If you are not going to use the deck for a long time, be sure to disconnect the deck from the wall outlet. To disconnect the AC power cord, grasp the plug itself; never pull the cord.

### On operation

If the deck is brought directly from a cold to a warm location, or is placed in a very damp room, moisture may condense on the lenses inside the deck. Should this occur, the deck may not operate properly. In this case, remove the MD and leave the deck turned on for about an hour until the moisture evaporates.

### On the MiniDisc cartridge

- Do not open the shutter to expose the MD.
- Do not place the cartridge where it will be subject to extremes of sunlight, temperature, moisture or dust.

### On cleaning

Clean the cabinet, panel and controls with a soft cloth slightly moistened with a mild detergent solution. Do not use any type of abrasive pad, scouring powder or solvent such as alcohol or benzene.

If you have any questions or problems concerning your deck, please consult your nearest Sony dealer.

---

## Welcome!

Thank you for purchasing the Sony MiniDisc Deck. Before operating the deck, please read this manual thoroughly and retain it for future reference.

---

## About This Manual

### Conventions

- Controls in the instructions are those on the deck; these may, however, be substituted by controls on the remote that are similarly named or, when different, appear in the instructions within brackets.
- The following icons are used in this manual:



Indicates a procedure that requires use of the remote.



Indicates tips for making the task easier and hints.

---

# TABLE OF CONTENTS

---

## Getting Started

Unpacking .....	4
Hooking Up the System .....	4

---

Recording on an MD .....	6
Playing an MD .....	8

---

## Recording on MDs

Notes on Recording .....	9
Useful Tips for Recording .....	9
Recording Over Existing Tracks .....	11
Adjusting the Recording Level .....	11
Marking Track Numbers While Recording (Track Marking) .....	12
Starting Recording With 6 Seconds of Prestored Audio Data (Time Machine Recording) .....	12
Synchro-Recording With Audio Equipment of Your Choice .....	13
Synchro-Recording With a Sony CD Player .....	14
Recording on an MD Using a Timer .....	15

---

## Playing MDs

Using the Display .....	16
Locating a Specific Track .....	17
Locating a Particular Point in a Track .....	18
Playing Tracks Repeatedly .....	18
Playing in Random Order (Shuffle Play) .....	19
Creating Your Own Program (Program Play) .....	20
Useful Tips When Recording From MDs to Tape .....	21
Playing an MD Using a Timer .....	21

---

## Editing Recorded MDs

Notes on Editing .....	22
Erasing Recordings (Erase Function) .....	22
Dividing Recorded Tracks (Divide Function) .....	24
Combining Recorded Tracks (Combine Function) .....	25
Moving Recorded Tracks (Move Function) .....	26
Labeling Recordings (Title Function) .....	26
Undoing the Last Edit (Undo Function) .....	29

---

## Additional Information

Display Messages .....	30
System Limitations .....	30
Troubleshooting .....	31
Specifications .....	31
Guide to the Serial Copy Management System .....	33

---

Index .....	34
-------------	----

## Unpacking

Check that you received the following items:

- Audio connecting cords (2)
- Remote commander (remote) RM-D7M (1)
- Sony SUM-3 (NS) batteries (2)

## Inserting batteries into the remote

You can control the deck using the supplied remote. Insert two R6 (size-AA) batteries by matching the + and - on the batteries. When using the remote, point it at the remote sensor  on the deck.

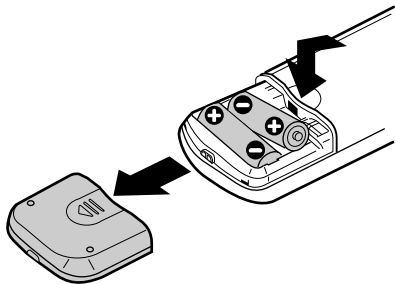

### When to replace batteries

With normal use, the batteries should last for about six months. When the remote no longer operates the deck, replace all the batteries with new ones.

### Notes

- Do not leave the remote near an extremely hot or humid place.
- Do not drop any foreign object into the remote casing, particularly when replacing the batteries.
- Do not expose the remote sensor to direct sunlight or lighting apparatuses. Doing so may cause a malfunction.
- If you don't use the remote for an extended period of time, remove the batteries to avoid possible damage from battery leakage and corrosion.

## Hooking Up the System

### Overview

This section describes how to hook up the MD deck to an amplifier or other components such as a CD player or DAT deck. Be sure to turn off the power of each component before connection.

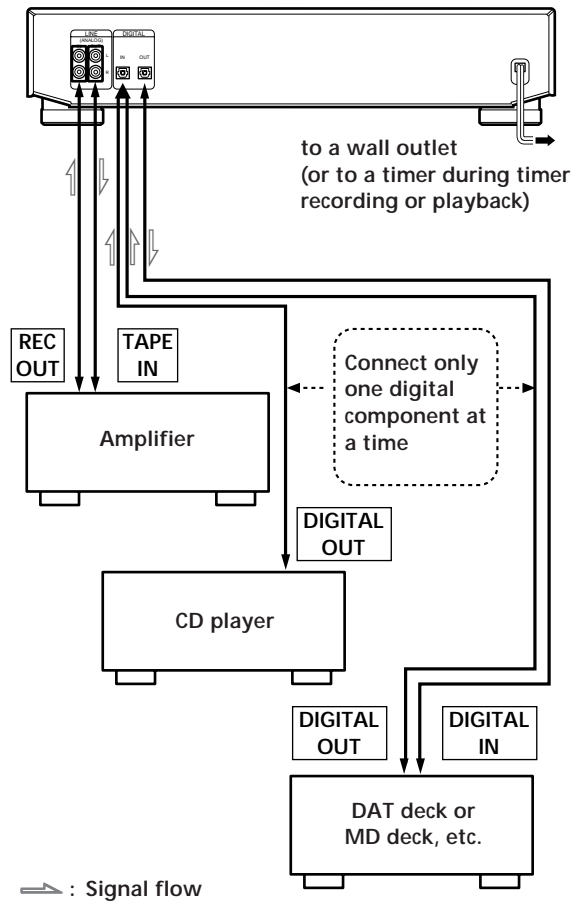

### What cords will I need?

- Audio connecting cords (supplied) (2)

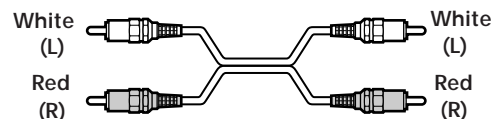

- Optical cable (not supplied) (2)

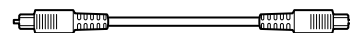

## Hookups

### Connecting the deck to an amplifier

Connect the amplifier to the LINE (ANALOG) IN/OUT jacks using the audio connecting cords (supplied), making sure to match the color-coded cords to the appropriate jacks on the components: red (right) to red and white (left) to white. Be sure to make connections firmly to prevent hum and noise.

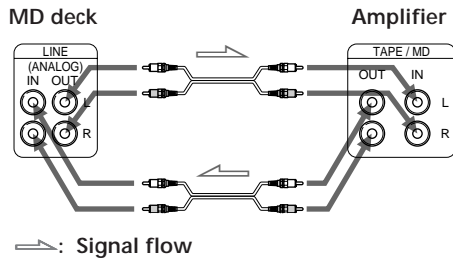

### Connecting the deck to a digital component such as a CD player, DAT deck, digital amplifier, or another MD deck

Connect the component through the DIGITAL IN/OUT connectors with two optical cables (not supplied). Take the caps off the connectors before plugging in the cables.

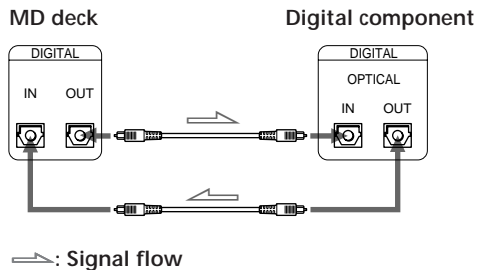

### Automatic conversion of digital sampling rates during recording

A built-in sampling rate converter automatically converts the sampling frequency of various digital sources to the 44.1 kHz sampling rate of your MD deck. This allows you to record sources such as 32- and 48-kHz DAT or satellite broadcasts, as well as compact discs and other MDs.

### Notes

- If “Din Unlock” or “Cannot Copy” appears in the display, recording through the digital connector is not possible. In this case, record the program source through the LINE (ANALOG) IN jacks with INPUT set to ANALOG.
- When recording through the DIGITAL IN connector, you cannot adjust the recording level.

## Connecting the AC power cord

Connect the AC power cord to a wall outlet or to the outlet of a timer.

# Recording on an MD

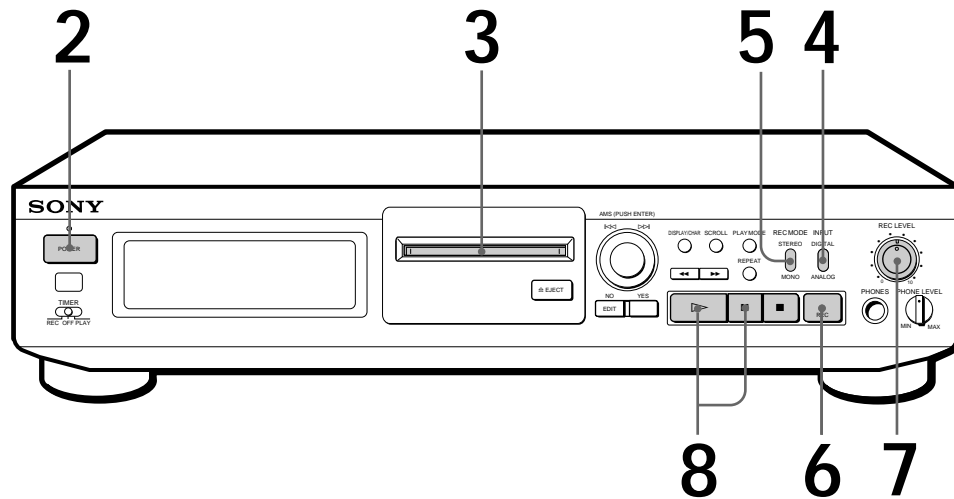

- 1** Turn on the amplifier and play the program source you want to record.
- 2** Press POWER.  
The POWER indicator changes from red to green.
- 3** Insert a recordable MD.

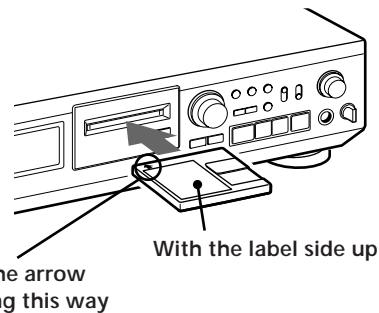

If the MD has a recorded material on it, the deck will automatically start recording from the end of the last recorded track.

- 4** Set INPUT to the corresponding input connector.

To record through	Set INPUT to
DIGITAL IN	DIGITAL
LINE (ANALOG) IN	ANALOG

- 5** Set REC MODE to the mode you want to record in.

To record in	Set REC MODE to
Stereo sound	STEREO
Monaural sound*	MONO

\* In the monaural recording, you can record about two times longer than in the stereo recording.

Monitor audio during recording  
Even if you set REC MODE to MONO, the monitor signal does not become monaural.

**6** Press ● REC.  
The deck becomes ready to record.

**7** When recording the analog input signal, adjust the recording level with REC LEVEL.  
The fourth dot is satisfactory for most purposes. For details, refer to “Adjusting the Recording Level” on page 11.

**8** Press ▷ or ■.  
Recording starts.

**9** Start playing the program source.

When “TOC” flashes in the display  
The deck is currently updating the Table Of Contents (TOC).  
Do not move the deck or pull out the AC power cord. Changes to an MD made through recording are saved only when you update the TOC by ejecting the MD or changing the deck to standby by pressing POWER.

**Do not disconnect the deck from the power source immediately after recording**

If you do, recorded material may not be saved to the MD. To save the material, after recording, press ≡ EJECT to take out the MD or change the deck to standby by pressing POWER. “TOC” will flash in the display at this time. After “TOC” stops flashing and goes out, you can pull out the AC power cord.

To	Press
Stop recording	■
Pause recording*	■. Press the button again or press ▷ to resume recording.
Take out the MD	≡ EJECT after stopping recording

\* Whenever you pause recording, the track number increases by one. For example, if you paused recording while recording on track 4, the track number increases by one and recording continues on the new track when restarted.

**To protect an MD against accidental erasure**

To make it impossible to record on an MD, slide the tab in the direction of arrow, opening the slot. To allow recording, close the slot.

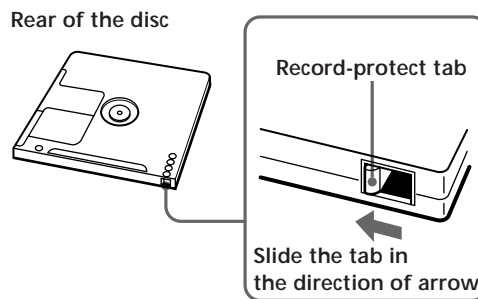

**Note**

If you switch REC MODE during recording or recording pause, recording stops.

# Playing an MD

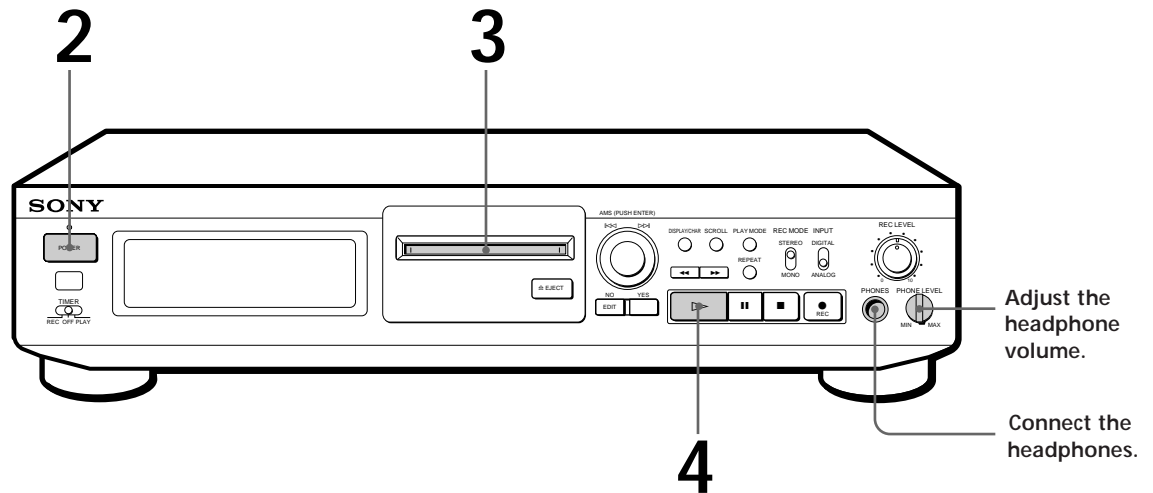

**1** Turn on the amplifier and set the source selector to the position for MD deck.

**2** Press POWER.  
The POWER indicator changes from red to green.

**3** Insert an MD.

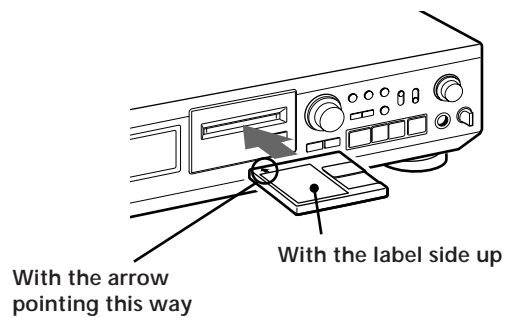

**4** Press  $\blacktriangleright$ .  
The deck starts playing. Adjust the volume on the amplifier.

You can locate and play back a track while the deck is stopped

- 1 Turn AMS (or press  $\blacktriangleleft\blacktriangleleft$  or  $\blacktriangleright\blacktriangleright$ ) until the number of the track you want to play appears.
- 2 Press AMS or  $\blacktriangleright$ .

To use headphones  
Connect them to PHONES jack. Use PHONE LEVEL to adjust the volume.

To	Do the following:
Stop playing	Press $\blacksquare$ .
Pause playing	Press $\blacksquare$ . Press the button again or press $\blacktriangleright$ to resume playing.
Go to the next track	Turn AMS clockwise (or press $\blacktriangleright\blacktriangleright$ on the remote).
Go to the preceding track	Turn AMS counterclockwise (or press $\blacktriangleleft\blacktriangleleft$ on the remote).
Take out the MD	Press $\square$ EJECT after stopping playing.



## Notes on Recording

### If "Protected" appears in the display

The MD is record-protected. Close the slot to record on the disc (see "To protect an MD against accidental erasure" on page 7).

### If "Din Unlock" flashes in the display

- The digital program source is not connected as you set with INPUT in Step 4 on page 6.  
To continue, connect the program source properly.
- The program source is not on.  
Turn on the program source.

Depending on source being recorded, track numbers are marked in following ways:

- When recording from a CD or MD with INPUT at DIGITAL and the source connected through DIGITAL IN: The deck automatically marks track numbers in the same sequence as the original. If, however, a track is repeated two or more times (e.g. by single-track repeat play) or two or more tracks with the same track number (e.g. from different MDs or CDs) are played, the track or tracks are recorded as part of a single, continuous track with a single track number.  
If the source is an MD, track numbers may not be marked for tracks of less than 4 seconds.
- When recording from source connected through LINE (ANALOG) IN with INPUT at ANALOG, and "LEVEL-SYNC" does not light up (see "Marking Track Numbers While Recording" on page 12) or when recording from DAT or satellite broadcasts connected through DIGITAL IN with INPUT at DIGITAL: The source will be recorded as a single track. You can divide the track afterwards using the Divide Function (see "Dividing Recorded Tracks" on page 24) or mark track numbers during recording by using the Track Marking Function on page 12.  
If "LEVEL-SYNC" appears in the display, the deck automatically marks track numbers when recording analog source or digital recording of DAT or satellite broadcasts (see "Marking track numbers automatically" on page 12).
- When recording from DAT or satellite broadcasts with INPUT at DIGITAL, the deck automatically marks a track number whenever the sampling frequency of the input signal changes.

### When "TOC" flashes in the display

The deck is currently updating the Table Of Contents (TOC). Do not move the deck or pull out the AC power cord. Changes to an MD made through recording are saved only when you update the TOC by ejecting the MD or changing the deck to standby by pressing POWER.

The MD deck uses the SCMS (Serial Copy Management System on page 33)

MDs recorded through digital input connector cannot be copied onto other MDs or DAT tapes through the digital output connector.

### When recording digital signals that have been emphasized (in the higher frequencies)

The signal is automatically de-emphasized (with attenuation proportional to the degree of emphasis) and the level of the de-emphasized signal is indicated on the peak level meters.

When the deck is recording or in recording pause, digital signals input through DIGITAL IN are output to DIGITAL OUT with the same sampling rate.

To change the digital input signal to another sampling rate for output (without recording it to an MD), use Input Monitor Function (see page 10).

## Useful Tips for Recording

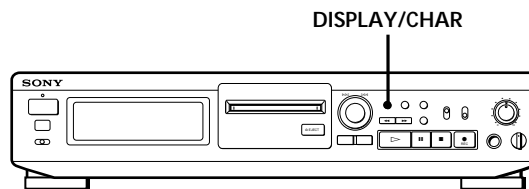

### Checking the remaining recordable time on the MD

- When you press DISPLAY/CHAR while recording, the remaining recordable time on the MD appears.
- When you press DISPLAY/CHAR repeatedly while the deck is stopped, the display changes as follows: total recorded time, remaining recordable time on the MD, disc name (see page 16).

(Continued)

### Monitoring the input signal (Input Monitor)

Before starting recording, you can monitor the selected input signal through the deck's output connectors.

- 1 Press  EJECT to remove the MD.
- 2 Set INPUT according to the input signal you want to monitor.

#### When INPUT is at ANALOG

The analog signal input through LINE (ANALOG) IN is output to DIGITAL OUT after A/D conversion, and then to the LINE (ANALOG) OUT connectors and PHONES jack after D/A conversion.

#### When INPUT is at DIGITAL

The digital signal input through DIGITAL IN is output to DIGITAL OUT, and then to the LINE (ANALOG) OUT connectors and PHONES jack after D/A conversion.

#### Note

Even if you set RECMODE to MONO, the monitor signal does not become monaural.

- 3 Press  REC.  
If INPUT is at ANALOG, "AD-DA" appears in the display.  
If INPUT is at DIGITAL, "-DA" appears in the display.

### If "Auto Cut" appears in the display (Auto Cut)

There has been no sound input for 30 seconds while INPUT is set to DIGITAL and the source is connected through DIGITAL IN. The 30 seconds of silence are replaced by a blank of about 3 seconds and the deck changes to recording pause.



You can turn off the Auto Cut Function. For details, see "If "Smart Space" appears in the display" below.

### If "Smart Space" appears in the display (Smart Space)

There has been an extended silence of 4 to 30 seconds in length when INPUT is set to DIGITAL and the source is connected through DIGITAL IN. The silence is replaced with a blank of about 3 seconds and the deck continues recording.

To turn off the Smart Space Function and Auto Cut Function

- 1 During recording pause, press EDIT/NO repeatedly until "S.Space?" appears in the display.
- 2 Press YES.
- 3 Press EDIT/NO to display "S.Space OFF."

To turn on the Smart Space Function and Auto Cut Function again

- 1 During recording pause, press EDIT/NO repeatedly until "S.Space?" appears in the display.
- 2 Press YES twice to display "S.Space ON."

#### Notes

- When you turn off the Smart Space Function, the Auto Cut Function is also turned off automatically.
- The Smart Space Function and Auto Cut Function are factory set on.
- The Smart Space Function does not affect the order of the track numbers being recorded, even if the blank space occurs in the middle of a track.
- If you turn off the deck or disconnect the AC power cord, the deck will recall the last setting (on or off) of the Smart Space and Auto Cut Functions the next time you turn on the deck.



### Playing back tracks just recorded

Do this procedure to immediately play back tracks that have just been recorded.

Press  immediately after stopping recording.

Playback starts from the first track of the material just recorded.

To play from the first track of the MD after recording

- 1 Press  again after stopping recording.
  - 2 Press .
- Playback starts from the first track of the MD.

## Recording Over Existing Tracks

Follow the procedure below to record over existing material just as you would on an analog cassette tape.

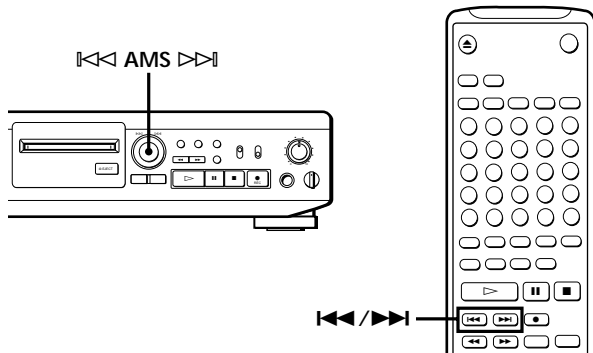

- 1 Do Steps 1 to 5 in “Recording on an MD” on page 6.
- 2 Turn AMS (or press ◀◀ or ▶▶) until the number of the track to be recorded over appears.
- 3 To record from the start of the track, continue from Step 6 in “Recording on an MD” on page 7.

**💡** While “TRACK” flashes in the display  
The deck is recording over an existing track, and stops flashing when it reaches the end of the recorded portion.

**💡** To record from the middle of the track  

- 1 After Step 2 above, press ▶ to start playback.
- 2 Press ■ where you want to start recording.
- 3 Continue from Step 6 in “Recording on an MD” on page 7.

### Note

You cannot record from the middle of an existing track when the “PROGRAM” or “SHUFFLE” is on.

## Adjusting the Recording Level

When recording with INPUT at ANALOG and the signal input through LINE (ANALOG) IN jacks, use REC LEVEL to adjust the recording level before starting recording.

You cannot adjust the recording level during digital recording.

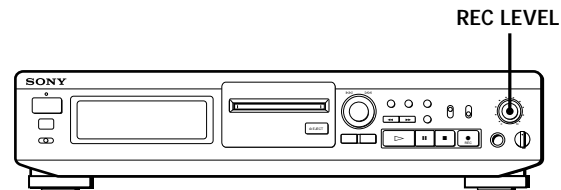

- 1 Do Steps 1 to 6 in “Recording on an MD” on pages 6 and 7.
- 2 Play the portion of the program source with the strongest signal level.
- 3 While monitoring the sound, turn REC LEVEL to adjust the recording level so that the peak level meters reach their highest point without turning on the OVER indication. Occasional lighting of “OVER” is acceptable.

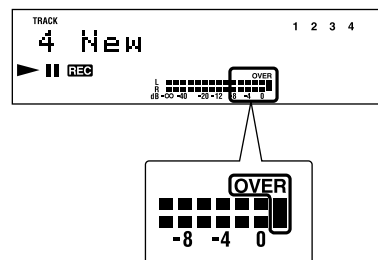

- 4 Stop playing the program source.
- 5 To start recording, do the procedure starting from Step 8 in “Recording on an MD” on page 7.

## Marking Track Numbers While Recording (Track Marking)

You can mark track numbers either manually or automatically. By marking track numbers at specific points, you can quickly locate the points later using the AMS Function or Editing Functions.

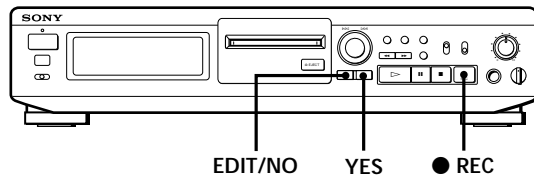

### Marking track numbers manually (Manual Track Marking)

You can mark track numbers at any time while recording on an MD.

Press ● REC at the place you want to add a track mark while recording.

### Marking track numbers automatically (Automatic Track Marking)

The deck adds track marks differently in the following cases:

- When recording from CDs or MDs with INPUT at DIGITAL and the source connected through DIGITAL IN:  
The deck marks track numbers automatically. When you record from a CD or MD, the track numbers are marked as they are found on the original.
- When recording with INPUT at ANALOG and the source connected through LINE (ANALOG) IN, or when recording from DAT or satellite broadcasts with INPUT at DIGITAL and the DAT or satellite broadcasts connected through DIGITAL IN:  
The deck marks a new track number whenever the signal level drops and rises to a certain point\* (Automatic Track Marking). If "LEVEL-SYNC" does not light up, set the LevelSync to ON as follows:

- 1 Press EDIT/NO to display "LevelSync?" during recording or recording pause.
- 2 Press YES twice to display "LevelSync ON." "LEVEL-SYNC" appears in the display.

To cancel Automatic Track Marking

- 1 Press EDIT/NO during recording or recording pause. "LevelSync?" appears in the display.
- 2 Press YES.
- 3 Press EDIT/NO. "LevelSyncOFF" appears in the display.

\* The signal level must remain low for 2 or more seconds before a new track number is marked.

💡 When you want to mark track numbers after you've finished recording

Use the Divide Function (see "Dividing Recorded Tracks" on page 24).

#### Note

If you turn off the deck or disconnect the AC power cord, the deck will recall the last setting (LevelSync on or off) of the Automatic Track Marking Function the next time you turn on the deck.

## Starting Recording With 2 Seconds of Prestored Audio Data (Time Machine Recording)

When recording from an FM or satellite broadcast, the first few seconds of material are often lost due to the time it takes you to ascertain the contents and press the record button. To prevent the loss of this material, the Time Machine Recording Function constantly stores 2 seconds of the most recent audio data in a buffer memory so that when you begin recording the program source, the recording actually begins with the 2 seconds of audio data stored in the buffer memory in advance, as shown in the illustration below:

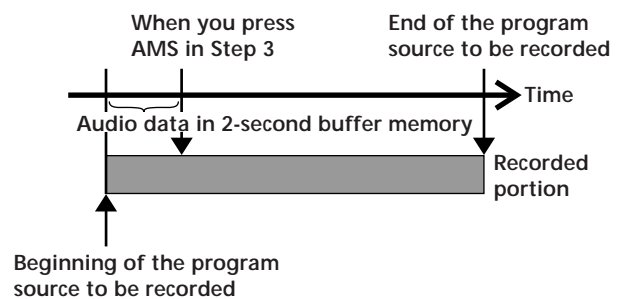

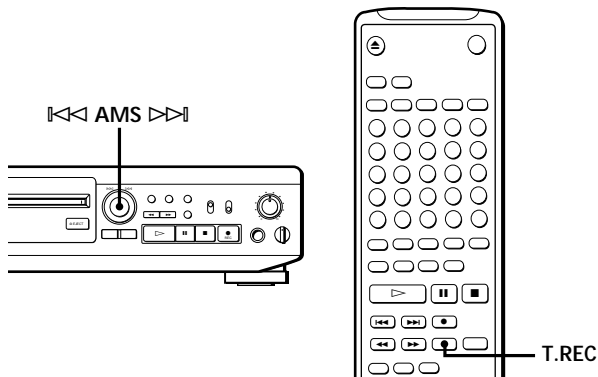

- 1 Do Steps 1 to 6 in “Recording on an MD” on pages 6 and 7.  
The deck changes to recording pause.
- 2 Start playing the program source you want to record.  
The most recent 2 seconds of audio data is stored in the buffer memory.
- 3 Press AMS (or T.REC) to start Time Machine Recording.  
Recording of the program source starts with the 2 seconds of audio data stored in the buffer memory.

 To stop Time Machine Recording  
Press ■.

#### Note

The deck starts storing audio data when the deck is in recording pause and you start playing the program source. With less than 2 seconds of playing of the program source and audio data stored in the buffer memory, Time Machine Recording starts with less than 2 seconds of audio data.

## Synchro-Recording With Audio Equipment of Your Choice

By using the MUSIC SYNC button on the remote, you can automatically start recording in sync with the signal input from the program source through the LINE (ANALOG) IN jacks or the DIGITAL IN connector (Music Synchro-Recording). The method of marking track numbers differs, depending on the program source being recorded and how the deck is connected to the program source. (See “Notes on Recording” on page 9.)

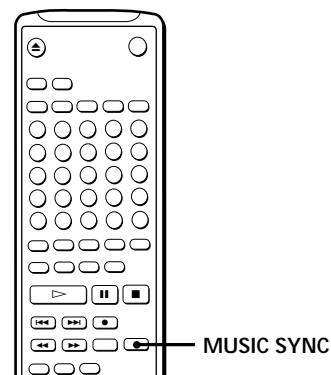

- 1 Do Steps 1 to 5 in “Recording on an MD” on page 6.
- 2 Press MUSIC SYNC.  
The deck changes to recording pause.
- 3 Start playing the program source you want to record.  
The deck starts recording automatically.

 To stop Music Synchro-Recording  
Press ■.

#### Note

When Music Synchro-Recording, the SmartSpace Function and the Auto Cut Function turn on automatically regardless of their setting (ON or OFF) and type of input (digital or analog).

## Synchro-Recording With a Sony CD Player

By connecting your deck to a Sony CD player or Hi-Fi Component System, you can easily dub CDs onto MDs using the CD synchro buttons on the remote. If your deck is connected to a Sony CD player by a digital input cable, track numbers are automatically marked as appear on the original regardless of whether “LevelSync ON” or “LevelSyncOFF” is selected. If your deck is connected to a Sony CD player by audio connecting cords through LINE (ANALOG) IN, track numbers are automatically marked when you select “LevelSync ON” (see “Marking Track Numbers While Recording” on page 12).

As the same remote controls both the CD player and the deck, you may have trouble operating both units if they are far from each other. If you do, place the CD player close to this deck.

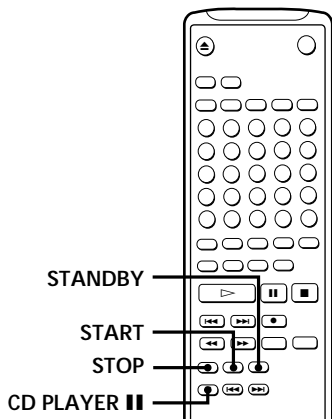

- 1 Set the source selector on the amplifier to CD.
- 2 Do Steps 2 to 5 in “Recording on an MD” on page 6 to prepare the deck for recording.
- 3 Insert a CD into the CD player.
- 4 Select the playback mode (Shuffle Play, Program Play, etc.) on the CD player.
- 5 Press STANDBY.  
The CD player pauses for playing and the deck pauses for recording.

- 6 Press START.  
The deck starts recording and the CD player starts playback.  
The track number and elapsed recording time of the track appear in the display.

If the CD player does not start playing  
Some CD player models may not respond when you press START on the remote of the deck. Press  on the remote of the CD player instead.

- 7 Press STOP to stop synchro-recording.

### To pause recording

Press STANDBY or CDPLAYER .

To restart recording, press START or CDPLAYER .  
A new track number is marked each time you pause recording.

### You can use the remote of the CD player during synchro-recording



When you press  the CD player stops and the deck pauses for recording.

When you press  the CD player pauses and the deck pauses for recording.

To restart synchro-recording, press .

### You can change CDs during synchro-recording

Do the following steps instead of Step 7 above.

- 1 Press  on the remote of the CD player.  
The deck pauses for recording.
- 2 Change the CD.
- 3 Press  on the remote of the CD player.  
Synchro-recording restarts.

### You can also do synchro-recording with a Sony video CD player

Using the procedure for synchro-recording with a Sony CD player, you can do synchro-recording with a Sony video CD player also.

To select the video CD player, press button number 2 while pressing down the POWER button before starting the procedure.

To select the CD player again, press button number 1 while pressing down the POWER button.

The deck is factory set to a CD player for synchro-recording.

### You can check the remaining recordable time on the MD

Press DISPLAY (see page 16).

## Recording on an MD Using a Timer

By connecting a timer (not supplied) to the deck, you can start and stop recording operations at specified times. For further information on connecting the timer and setting the starting and ending times, refer to the instructions that came with the timer.

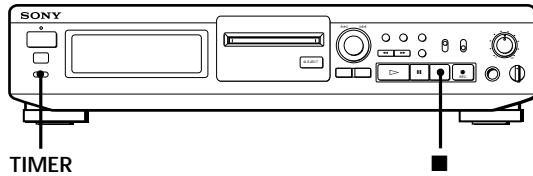

- 1 Do Steps 1 to 7 in “Recording on an MD” on pages 6 and 7.
- 2
  - If you want to specify the time for the start of recording, press ■.
  - If you want to specify the time for the end of recording, do Steps 8 and 9 of “Recording on an MD” on page 7.
  - If you want to specify the time for both start and end of recording, press ■.
- 3 Set TIMER on the deck to REC.
- 4 Set the timer as required.
  - When you have set the time for the start of recording, the deck turns off. When the specified time arrives, the deck turns on and starts recording.
  - When you have set the time for the end of recording, recording continues. When the specified time arrives, the deck stops recording and turns off.
  - When you have set the time for both the start and end of recording, the deck turns off. When the starting time arrives, the deck turns on and starts recording. When the ending time arrives, the deck stops recording and turns off.

- 5 After you have finished using the timer, set TIMER on the deck to OFF. Then place the deck in standby status by plugging the AC power cord of the deck into a wall outlet or set the timer to continuous operation.
  - If TIMER is left at REC, the deck will automatically start recording the next time you turn the deck on.
  - If you do not change the deck to standby status for more than a month after timer recording has finished, the recorded contents may disappear.

Make sure to change the deck to standby status within a month after timer recording is completed

The TOC on the MD is updated and recorded contents are written to the MD when you turn the deck on. If the recorded contents have disappeared, “STANDBY” flashes when you turn the deck on.

### Notes

- During timer recording, new material is recorded from the end of the recorded portion on the MD.
- Material recorded during timer recording will be saved to the disc the next time you turn the deck on. “TOC” will flash in the display at that time. Do not move the deck or pull out the AC power cord while “TOC” is flashing.
- Timer recording will stop if the disc becomes full.



## Using the Display

You can use the display to check disc and track information such as the total track number, total playing time of the tracks, remaining recordable time of the disc and disc name.

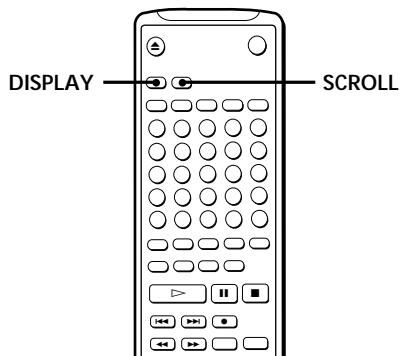
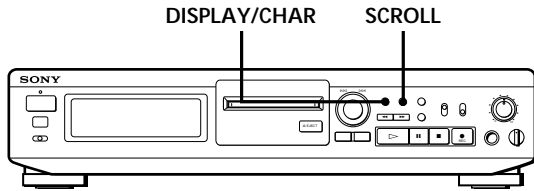

### Checking the total track number, total disc playing time, remaining recordable time of the disc and the title of the disc

Each time you press DISPLAY/CHAR (or DISPLAY) while the deck is stopped, you can change the display as follows:

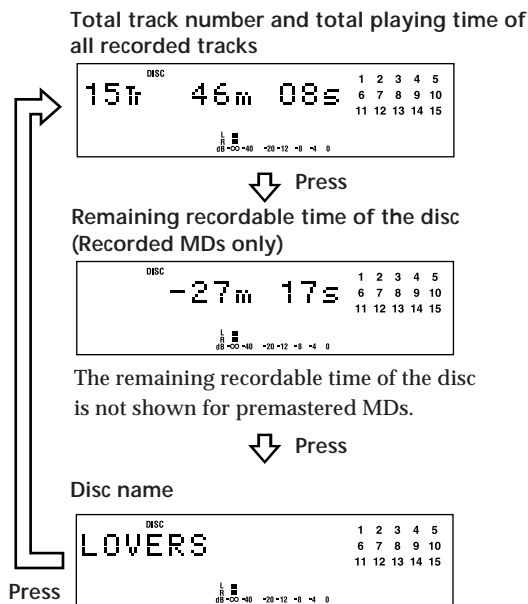

When you insert an MD, the disc name, total number of tracks, and total disc playing time appear in the display as follows:

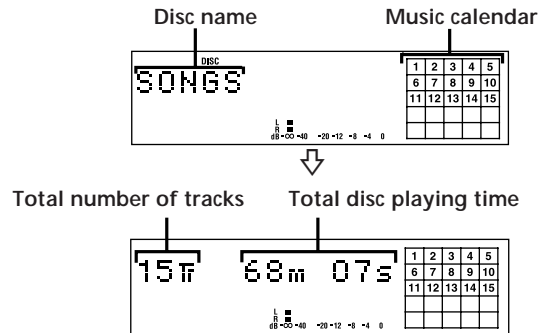

The disc name appears, followed by the total number of tracks (Tr) and total disc playing time.

A music calendar showing all the track numbers appears within a grid if the MD is a premastered disc, or without a grid if the MD is a recordable disc. If the total track number exceeds 25, ► appears to the right of number 25 in the music calendar.

To label a recordable disc and its tracks, see "Labeling Recordings" on page 26.

#### Note

When you insert a new MD or turn off the deck and turn it on again, the last item displayed will reappear. If, however, you disconnect the AC power cord, the display will show the total track number and total playing time of all recorded tracks the next time you turn on the deck, no matter what the last display was.

### Checking remaining time and the title of a track

Each time you press DISPLAY/CHAR (or DISPLAY) while playing an MD, you can change the display as shown below. The track numbers in the music calendar disappear after they are played.

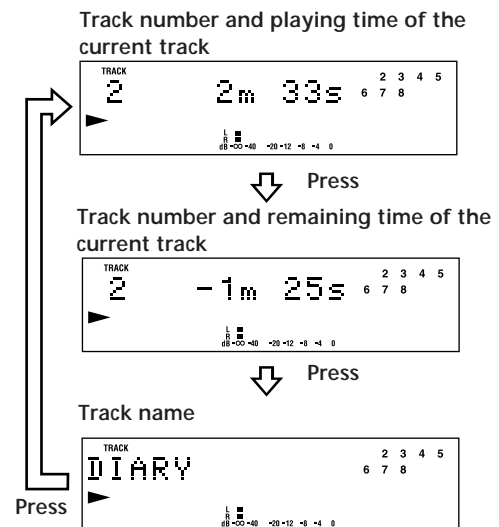

If no title is recorded, "No Name" appears, followed by the elapsed playing time.





- 💡 You can check the track name at any time while playing an MD  
Press SCROLL.  
Since the display shows up to 12 characters at a time, press SCROLL again to see the rest of the track title if the title has 13 characters or more.  
Press SCROLL again to pause scrolling, and again to continue scrolling.

## Locating a Specific Track

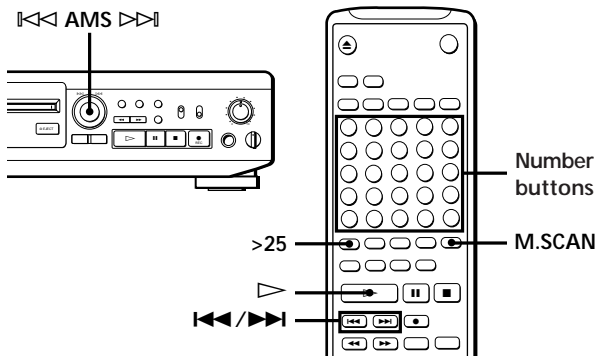

You can quickly locate any track while playing a disc by using AMS (Automatic Music Sensor), ◀◀ and ▶▶, number buttons or M.SCAN on the remote.



- 💡 When you directly locate a track with a number over 25   
You must press >25 first, before entering the corresponding digits.  
Press >25 once if it is a 2-digit track number, and twice if it is a 3-digit track number.  
To enter "0," press button 10.  
Examples: • To play track number 30  
Press >25 once, then 3 and 10.  
• To play track number 100  
Press >25 twice, then 1, 10 and 10.

- 💡 You can extend the playing time during music scan   
While the deck is stopped, press M.SCAN repeatedly until the playing time you want (6, 10 or 20 seconds) appears in the display. Each press changes the time in order of 6 to 20, then from 6 again.

- 💡 To pause playing at the beginning of a track  
Turn AMS (or press ◀◀ or ▶▶) after pausing playback.
- 💡 To go quickly to the beginning of the last track  
Turn AMS counterclockwise (or press ◀◀) while the display shows the total track number and total disc playing time, remaining recordable time of the disc, or disc name (see page 16).

To locate	Do the following:
The next or succeeding tracks	During playback, turn AMS clockwise or press ▶▶ repeatedly until you find the track.
The current or preceding tracks	During playback, turn AMS counterclockwise or press ◀◀ repeatedly until you find the track.
A specific track directly 	Press number buttons to enter the track number.
A specific track by using AMS	<ol style="list-style-type: none"> <li>1 Turn AMS until the track number you want to locate appears while the deck is stopped. (The track number is flashing.)</li> <li>2 Press AMS or ▷.</li> </ol>
By scanning each track for 6 seconds (music scan) 	<ol style="list-style-type: none"> <li>1 Press M.SCAN before you start playing.</li> <li>2 When you find the track you want, press ▷ to start playing.</li> </ol>

## Locating a Particular Point in a Track

You can also use ◀◀ and ▶▶ to locate a particular point in a track during playback or playback pause.

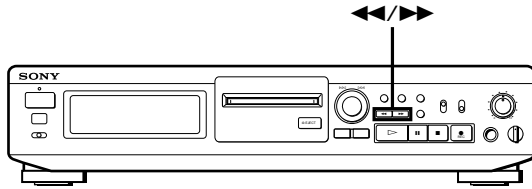

To locate a point	Press
While monitoring the sound	▶▶ (forward) or ◀◀ (backward) and keep pressing until you find the point.
Quickly by observing the display during playback pause	▶▶ or ◀◀ and keep pressing until you find the point. There is no sound output during this operation.

### Notes

- If the disc reaches the end while you are pressing ▶▶ during playback pause, "OVER" appears in the display. Press ◀◀ (or ◀◀◀) or turn AMS counterclockwise to go back.
- If the disc reaches the end while you are pressing ▶▶ during sound monitoring, the deck stops.
- Tracks that are only a few seconds long may be too short to scan using the search function. For such tracks, it is better to play the MD at normal speed.

## Playing Tracks Repeatedly

You can play tracks repeatedly in any play mode.

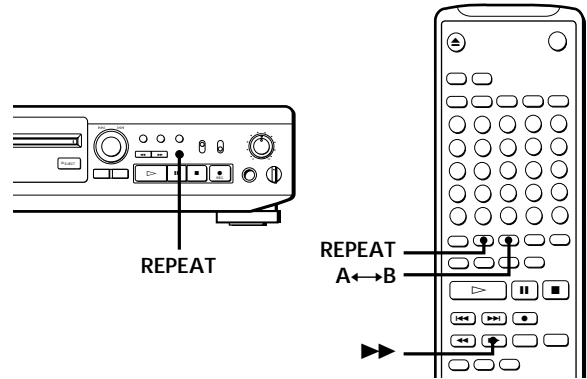

Press REPEAT.

"REPEAT" appears in the display.

The deck repeats the tracks as follows:

When the MD is played in	The deck repeats
Normal play (page 8)	All the tracks
Shuffle Play (page 19)	All the tracks in random order
Program Play (page 20)	The same program

### To cancel repeat play

Press REPEAT several times until "REPEAT" disappears. The deck returns to the original playing mode.

### Repeating the current track

While the track you want to repeat is playing in normal play, press REPEAT several times until "REPEAT 1" appears in the display.

## Repeating a specific portion (A-B Repeat)



You can play a specific portion of a track repeatedly. This might be useful when you want to memorize lyrics.

Note that you can only repeat a portion within the boundaries of a single track.

- 1 While playing a disc, press A↔B at the starting point (point A) of the portion to be played repeatedly.  
“REPEAT A-” flashes in the display.
- 2 Continue playing the track or press ►► until you reach the ending point (point B), then press A↔B again.  
“REPEAT A-B” lights continuously. The deck starts to play the specified portion repeatedly.

### To cancel A-B Repeat

Press REPEAT or ■.

### Setting new starting and ending points

You can repeat the portion immediately after the currently specified portion by changing the starting and ending points.

- 1 Press A↔B while “REPEAT A-B” appears.  
The current ending point B becomes the new starting point A and “REPEAT A-” flashes in the display.
- 2 Continue playing the track or press ►► until you reach the new ending point (point B), then press A↔B again.  
“REPEAT A-B” lights continuously and the deck starts playing repeatedly the newly specified portion.

### Note

If you turn off the deck or disconnect the AC power cord, the deck will recall the last setting of the Repeat Function the next time you turn on the deck.

The A-B Repeat settings, however, are lost.

## Playing in Random Order (Shuffle Play)

You can have the deck “shuffle” tracks and play them in random order.

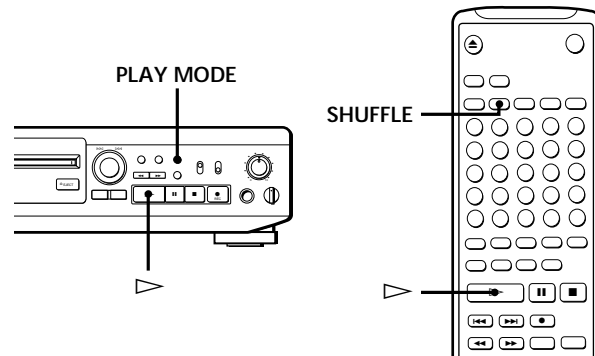

- 1 Press PLAY MODE repeatedly (or SHUFFLE once) until “SHUFFLE” appears in the display when the deck is stopped.
- 2 Press ▶ to start Shuffle Play.  
“◻” appears in the display while the deck is “shuffling” the tracks.

### To cancel Shuffle Play

Press PLAY MODE repeatedly (or CONTINUE once) until “SHUFFLE” disappears.



### You can specify tracks during Shuffle Play

- To play the next track, turn AMS clockwise (or press ►►).
- To play from the beginning of the current track again, turn AMS counterclockwise (or press ◀◀). You cannot use AMS (or ◀◀) to go to tracks that have already been played.

## Creating Your Own Program (Program Play)

You can specify the playback order of the tracks on an MD and create your own programs containing up to 25 tracks.

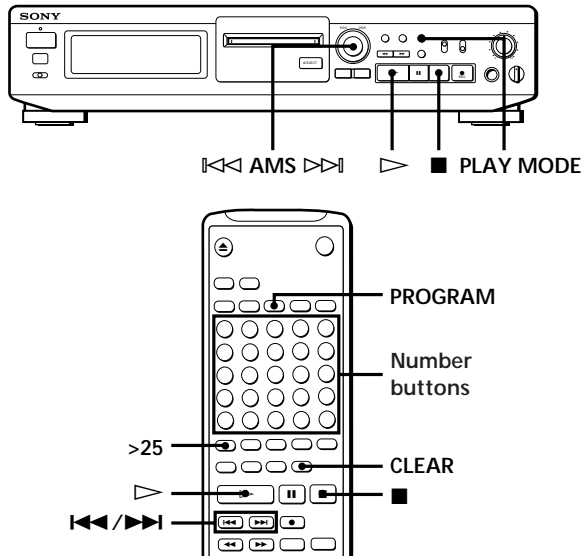

- 1 Press PLAY MODE repeatedly (or PROGRAM once) until "PROGRAM" appears in the display when the deck is stopped.
- 2 Do either a) or b):
  - a) When using the remote
    - Press the number buttons to enter the tracks you want to program in the order you want. To program a track with a number over 25, use the >25 button (see page 17).
    - If you've made a mistake Press CLEAR, then press the right number button.
  - b) When using the controls on the deck
    - 1 Turn AMS until the track number you want appears in the display.
    - 2 Press AMS or PLAY MODE.
- 3 Repeat Step 2 to enter other tracks. Each time you enter a track, the total program time is added up and appears in the display.
- 4 Press ▷ to start Program Play.

### To cancel Program Play

Press PLAY MODE repeatedly (or CONTINUE once) when the deck is stopped until "PROGRAM" disappears.

You can program the same track repeatedly. While the track number appears in the display, press AMS as many times as you want.

The program remains even after Program Play ends. When you press ▷, you can play the same program again.

### Notes

- The program created by the Program Play Function is lost when you turn off the deck or disconnect the AC power cord. The program is, however, recalled during timer playback.
- The display shows "- m - s" instead of the total playing time when the total playing time of the program exceeds 160 minutes.

### Checking the track order

You can check the order of tracks in your program during playback or playback pause.

Turn AMS (or press ◀◀ or ▶▶) during playback or playback pause. The track numbers appear in the order they were programmed.

### Changing the track order

You can change the order of the tracks in your program before you start playing.

To	Do the following:
Erase the last track in the program	Press CLEAR. Each time you press the button, the last track will be cleared.
Add tracks to the end of the program	Do Steps 2 and 3 in "Creating Your Own Program."
Change the whole program completely	<ol style="list-style-type: none"> <li>1 Press ■ while the deck is stopped.</li> <li>2 Do Steps 2 and 3 in "Creating Your Own Program."</li> </ol>

## Useful Tips When Recording From MDs to Tape

The Auto Space and Auto Pause Functions described in this section make recording from MDs to tape more easy.

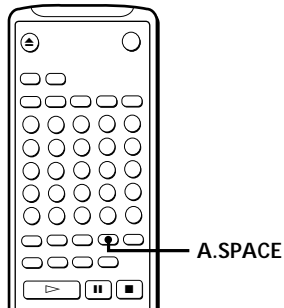

### Inserting blank spaces while recording to tape (Auto Space)

The Auto Space Function inserts a 3-second blank space between each track while recording from MDs to tapes, allowing you to use the AMS function during later playback.

Press A.SPACE repeatedly until "A.SPACE" appears in the display.

#### To cancel Auto Space

Press A.SPACE repeatedly until "A.SPACE" disappears.

#### Note

If the Auto Space Function is on while recording a selection containing multiple track numbers, (for example, a medley or symphony), blank spaces will be inserted within the selection whenever the track number changes.

### Pausing after each track (Auto Pause)

When the Auto Pause Function is on, the deck pauses after playing each track. Auto Pause is convenient when recording single tracks or multiple, non-consecutive tracks.

Press A.SPACE repeatedly until "A.PAUSE" appears in the display.

#### To restart playback

Press  or .

#### To cancel Auto Pause

Press A.SPACE repeatedly until "A.PAUSE" disappears.

#### Note

If you turn off the deck or disconnect the AC power cord, the deck will recall the last setting of the Auto Space and Auto Pause Functions the next time you turn on the deck.

## Playing an MD Using a Timer

By connecting a timer (not supplied) to the deck, you can start and stop playback operations at specified times. For further information on connecting the timer or setting the starting and ending times, refer to the instructions that came with the timer.

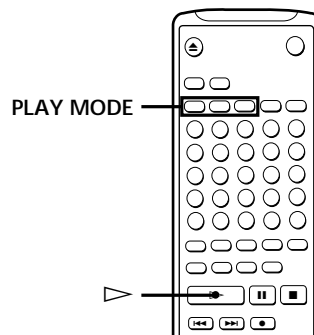
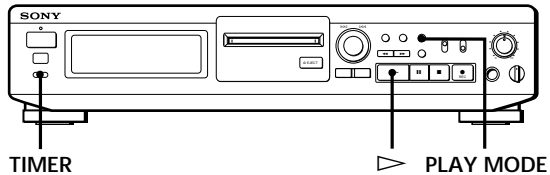

- 1 Do Steps 1 to 3 in "Playing an MD" on page 8.
- 2 Press PLAY MODE repeatedly (or one of the PLAY MODE buttons once) to select the play mode you want.  
To play only specific tracks, create a program (see page 20).
- 3
  - If you want to specify the time for the start of playback, go to Step 4.
  - If you want to specify the time for the end of playback, press  to start playback, then go to Step 4.
  - If you want to specify the time for both start and end of playback, go to Step 4.
- 4 Set TIMER on the deck to PLAY.

(Continued)

- 5 Set the timer as required.
  - When you have set the time for the start of playback, the deck turns off. When the specified time arrives, the deck turns on and starts playing.
  - When you have set the time for the end of playback, playback continues. When the specified time arrives, the deck stops playing and turns off.
  - When you have set the time for both the start and end of playback, the deck turns off. When the starting time arrives, the deck turns on and starts playing. When the ending time arrives, the deck stops playing and turns off.
- 6 After you have finished using the timer, set **TIMER** on the deck to **OFF**.

### Note

You can select Program Play in Step 2. Note, however, that programs eventually fade away when the standby status is off, and therefore if you set the time too far in the future, the program may be gone when the specified time arrives. If this has occurred, the deck enters normal play mode at the specified time and the tracks play in consecutive order.

### Notes on Editing

You can edit the recorded tracks after recording, using the following functions:

- Erase Function allows you to erase recorded tracks simply by specifying the corresponding track number.
- Divide Function allows you to divide tracks at specified points so that you can quickly locate those points afterwards, using the AMS function.
- Combine Function allows you to combine two consecutive tracks into one.
- Move Function allows you to change the order of tracks by moving a specific track to a track position you want.
- Title Function allows you to create titles for your recorded MDs and tracks.

### If "Protected" appears in the display

The deck could not edit because the record-protect slot on the MD is open. Edit after closing the slot.

### When "TOC" flashes in the display

Do not move the deck or pull out the AC power cord. After editing, "TOC" lights continuously until you eject the MD or turn off the power. "TOC" flashes while the deck is updating the TOC. When the deck finishes updating the TOC, "TOC" goes off.

### Erasing Recordings (Erase Function)

Do the procedures below to erase following:

- A single track
- All tracks
- Parts of a track

**Note, however, that once erased, MD data cannot be recovered.**

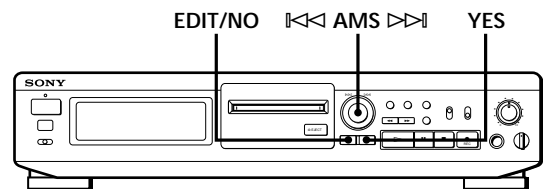

## Erasing a single track

You can erase a track simply by specifying the respective track number. When you erase a track, the total number of tracks on the MD decreases by one and all tracks following the erased one are renumbered. Since erasing merely updates the TOC, there is no need to record over material.

 To avoid confusion when erasing multiple tracks, you should proceed in order of high to low track number to prevent the renumbering of tracks that have not been erased yet.

Example: Erasing B

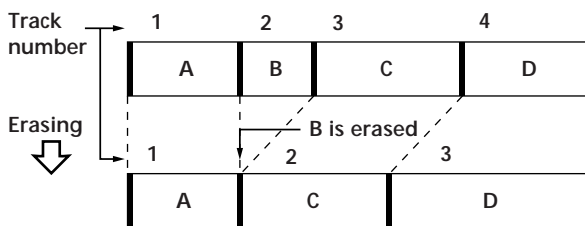

- 1 Turn AMS until the track number you want to erase appears in the display.
- 2 Press EDIT/NO repeatedly until "Erase?" appears in the display. The track number you selected starts flashing in the music calendar.
- 3 Press YES. When the track selected in Step 1 has been erased, "Complete" appears for a few seconds and the total number of tracks in the music calendar decreases by one. If you erase a track during playback, the track following the deleted track begins playing afterwards.
- 4 Repeat Steps 1 to 3 to erase more tracks.

### To cancel the Erase Function

Press EDIT/NO, , or turn AMS to change the track number.

### Note

If "Erase!?" appears in the display, the track was recorded or edited on another MD deck and is record-protected. If this indication appears, press YES to erase the track.

## Erasing all tracks on an MD

Erasing a recordable MD deletes the disc name, all recorded tracks, and titles (see page 29).

- 1 While the deck is stopped, press EDIT/NO repeatedly until "All Erase?" appears in the display.
- 2 Press YES. All tracks in the music calendar start flashing.
- 3 Press YES again. When the disc name, all recorded tracks, and titles on the MD have been erased, "Complete" appears for a few seconds and the music calendar disappears.

### To cancel the Erase Function

Press EDIT/NO or .

## Erasing a part of a track

By using the Divide (see page 24), Erase (see page 22) and Combine (see page 25) Functions, you can erase specific portions of a track.

Example: Erasing a part of track A

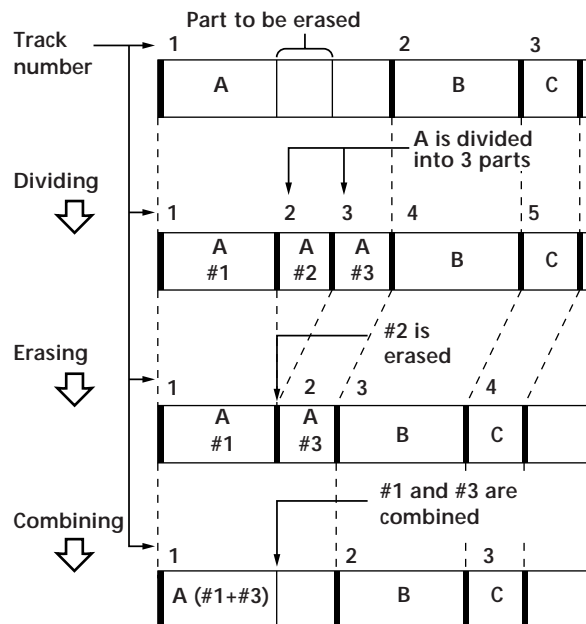

## Dividing Recorded Tracks (Divide Function)

With the Divide Function you can assign a track number at places that you want to randomly access afterwards. Use this function to add tracks to MDs recorded from an analog source (and therefore contain no track numbers), or to divide an existing track into multiple portions. When you divide a track, the total number of tracks on the MD increases by one and all tracks following the divided track are renumbered.

Example: Dividing track 2 to create a new track for C

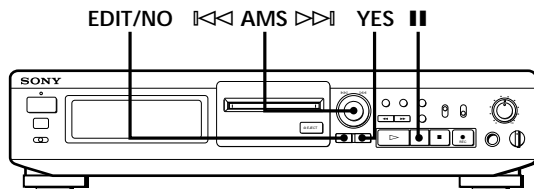
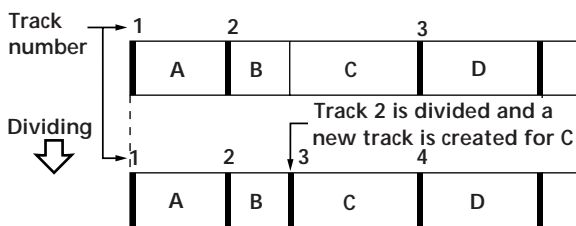

- 1 While playing the MD, press **II** at the point where you want to create a new track. The deck pauses playing.
- 2 Press **EDIT/NO** repeatedly until "Divide?" appears in the display.
- 3 Press **YES** to divide the track. "Rehearsal" alternates with "Position ok?" in the display, the track to be divided starts flashing in the music calendar, and the starting portion of the new track begins playing repeatedly.
- 4 If the starting position is incorrect, press **EDIT/NO**. (If it is correct, go to Step 7.)

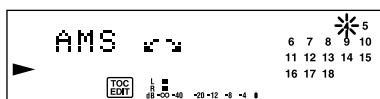

- 5 While monitoring the sound, turn **AMS** to find the starting position of the new track. The starting portion of the new track is played back repeatedly. "Rehearsal" alternates with "Position ok?" in the display. The starting position can be moved within a maximum range of -128 to +127 steps of about 0.06 second each within a track.
- 6 If the starting position is still incorrect, repeat Step 5 until it is correct.
- 7 Press **YES** or **AMS** when the position is correct. When the track has been divided, "Complete" appears for a few seconds and the newly created track begins playing. The new track will have no track title even if the original track was labeled.

To cancel the Divide Function  
Press **■**.

You can undo a track division  
Combine the tracks again (see "Combining Recorded Tracks" on page 25) then redivide the tracks if necessary.

You can divide a track while recording  
Use the Track Marking Function (see page 12).



## Combining Recorded Tracks (Combine Function)

Use the Combine Function while the deck is stopped, playing or in pause to combine consecutive tracks on a recorded MD. This function is useful for combining several songs into a single medley, or several independently recorded portions into a single track. When you combine two tracks, the total number of tracks decreases by one and all tracks following the combined tracks are renumbered.

Example: Combining B and C

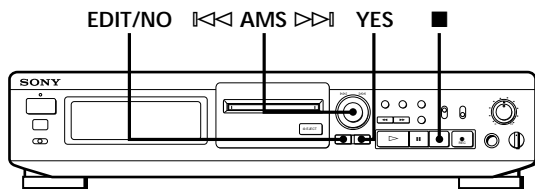
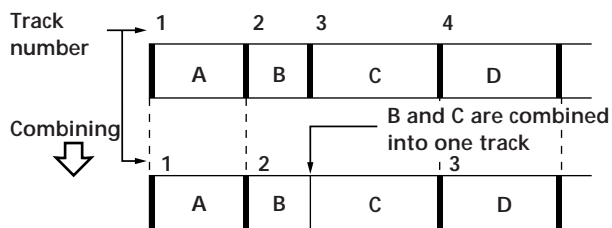

- 1 Turn AMS until the second track of the two to be combined appears.  
For example, when combining tracks 3 and 4, turn AMS until 4 appears.
- 2 Press EDIT/NO repeatedly until “Combine ?” appears in the display.
- 3 Press YES.  
“Rehearsal” alternates with “Track ok?” in the display. The place where the two tracks will join (i.e., the end of the first track and the beginning of the second track) repeatedly plays back and the respective track number flashes in the music calendar.
- 4 If the track is the wrong one, press EDIT/NO or ■, then start from Step 1 again.
- 5 If the place is correct, press YES.  
When the tracks have been combined, “Complete” appears for a few seconds and the total number of tracks in the music calendar decreases by one. If both of the combined tracks have track titles, the title of the second track is erased.

To cancel the Combine Function  
Press EDIT/NO or ■.



You can undo a track combination

Divide the tracks again (see “Dividing Recorded Tracks” on page 24), then repeat the combine function with the correct tracks if necessary.

### Note

If “Sorry” appears in the display, the tracks cannot be combined. This sometimes happens when you’ve edited the same track many times, and is due to a technical limitation of the MD system, not a mechanical error.

## Moving Recorded Tracks (Move Function)

Use the Move Function to change the order of any track. After you move a track, the track numbers between the new and old track positions are automatically renumbered.

Example: Moving track C to track position 2

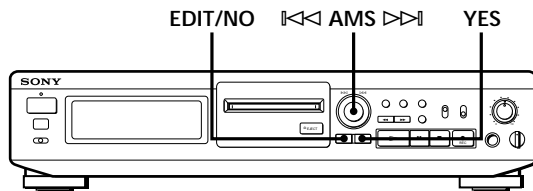
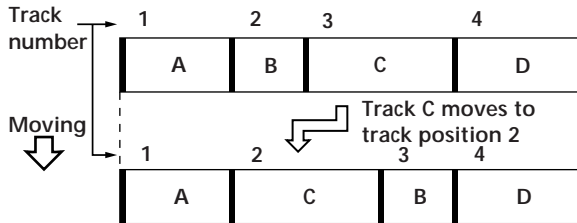

- 1 Turn AMS until the track number you want to move appears in the display.
- 2 Press EDIT/NO repeatedly until "Move ?" appears in the display.
- 3 Press YES.  
The track number to be moved and the new track position appears.

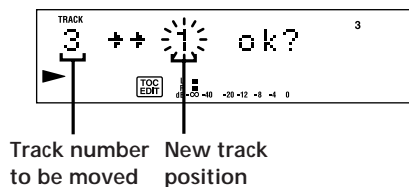

- 4 Turn AMS until the new track position appears.

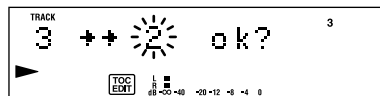

- 5 Press YES or AMS.  
After you have moved the track, "Complete" appears for a few seconds and the moved track begins playing back if the deck is in playback mode.

To cancel the Move Function  
Press EDIT/NO or ■.

## Labeling Recordings (Title Function)

You can create titles for your recorded MDs and tracks. Titles — which may consist of uppercase and lowercase letters, numbers and symbols for a maximum of about 1,700 characters per disc — appear in the display during MD operation.

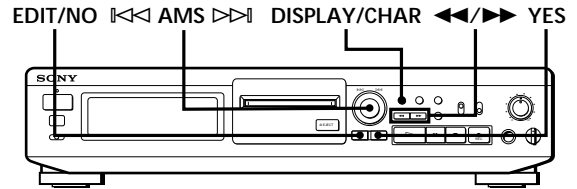

Use the following procedure to label a track or an MD. You can label a track while it is playing, pausing or recording. If the track is playing or recording, be sure to finish labeling before the track ends. If the track ends before you've completed the labeling procedure, the characters already entered are not recorded and the track will remain unlabeled.

- 1 Press EDIT/NO repeatedly until "Name in ?" appears in the display, then do the following:

To label	Make sure that the deck is
A track	Playing, pausing, recording the track to be labeled, or stopped after locating the track to be labeled
An MD	Stopped with no track number appearing in the display

- 2 Press YES.  
A flashing cursor appears in the display.

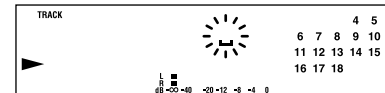

3 Press DISPLAY/CHAR to select the character type as follows:

To select	Press DISPLAY/CHAR repeatedly until
Uppercase letters	"A" appears in the display
Lowercase letters	"a" appears in the display
Numbers	"0" appears in the display

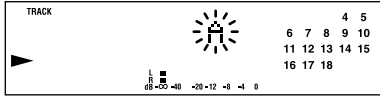

4 Turn AMS to select the character.

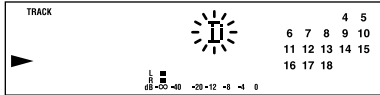

The selected character flashes.

Letters, numbers, and symbols appear in sequential order as you turn AMS.

You can use the following symbols in titles:

! " # \$ % & ' ( ) \* + , - . / : ; < = > ? @ \_ `

You can press DISPLAY/CHAR to change the character type at any time during Step 4 (see Step 3).

5 Press AMS to enter the selected character. The cursor shifts rightward and waits for the input of the next character.

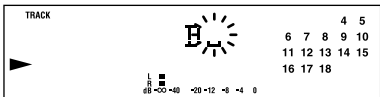

6 Repeat Steps 3 to 5 until you have entered the entire title.

If you entered the wrong character

Press ◀ or ▶ until the character to be corrected starts flashing, and repeat Steps 3 to 5 to enter the correct character.

To erase a character

Press ◀ or ▶ until the character to be erased starts flashing, then press EDIT/NO.

To enter a space

Press AMS or ▶ while the cursor is flashing.

7 Press YES.

This completes the labeling procedure and the title appears on the left side of the display.

To cancel labeling

Press ■.

Note

You cannot label a track or an MD while you are recording over an existing track.

(Continued)

## Labeling tracks and MDs with the remote

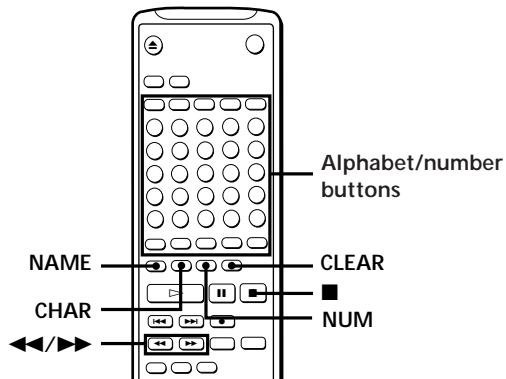

- 1 Press NAME repeatedly until a flashing cursor appears in the display, then do the following:

To label	Make sure that the deck is
A track	Playing, pausing, recording the track to be labeled, or stopped after locating the track to be labeled
An MD	Stopped with no track number appearing in the display

- 2 Select the character type as follows:

To select	Press
Uppercase letters	CHAR repeatedly until "Selected ABC" appears in the display
Lowercase letters	CHAR repeatedly until "Selected abc" appears in the display
Numbers	NUM repeatedly until "Selected 123" appears in the display

- 3 Enter one character at a time.  
After you enter a character, the cursor shifts rightward and waits for the input of the next character.

- 4 Repeat Steps 2 and 3 until you have entered the entire title.

If you entered the wrong character

Press ◀ or ▶ until the character to be corrected starts flashing.

Press CLEAR to erase the incorrect character, then enter the correct one.

- 5 Press NAME again.  
The entered title appears on the left side of the display window after the label has been recorded.

To cancel labeling

Press ■.

## Changing an existing title

- 1 Press NAME, then do the following:

To change	Make sure that the deck is
A track title	Playing, pausing the track whose title is to be changed, or stopped after locating the track whose title is to be changed
A disc name	Stopped with no track number appearing in the display

- 2 Keep pressing CLEAR (or EDIT/NO on the deck) until the current title is erased.
- 3 Enter the new title.  
Do Steps 3 to 6 of “Labeling Recordings” on page 26, or Steps 2 to 4 of “Labeling tracks and MDs with the remote” on page 28.
- 4 Press NAME.

## Erasing all titles on a disc (Name Erase Function)

Use this function to erase all titles on an MD simultaneously.

Note that once erased, titles cannot be recovered.

- 1 Press EDIT/NO repeatedly while the deck is stopped until “All Erase ?” appears in the display.
- 2 Press EDIT/NO again.  
“Name Erase ?” appears in the display.
- 3 Press YES.  
All titles are erased.

### To cancel the Name Erase Function

Press ■.



You can erase all recorded tracks and titles  
See “Erasing all tracks on an MD” on page 23.

## Undoing the Last Edit (Undo Function)

You can use the Undo Function to cancel the last edit and restore the contents of the MD to the condition that existed before editing was done. Note, however, that you cannot undo an edit if you do any of the following after the edit:

- Press the ● REC button on the front panel.
- Press the ● button, the MUSIC SYNC button, or the CD-SYNC STANDBY button on the remote.
- Update the TOC by turning off the power or ejecting the MD.
- Disconnect the AC power cord.

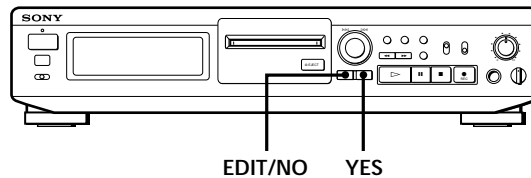

- 1 With the deck stopped and no track number appearing in the display, press EDIT/NO repeatedly until “Undo ?” appears in the display. “Undo ?” does not appear if no editing has been done.

- 2 Press YES.  
One of the following messages appears in the display, depending on the type of editing to be undone:

Editing done:	Message:
Erasing a single track	“Erase Undo ?”
Erasing all tracks on an MD	
Dividing a track	“Divide Undo ?”
Combining tracks	“Combine Undo ?”
Moving a track	“Move Undo ?”
Labeling a track or an MD	
Changing an existing title	“Name Undo ?”
Erasing all titles on an MD	

- 3 Press YES again.  
“Complete” appears for a few seconds and the contents of the MD are restored to the condition that existed before the edit.

### To cancel the Undo Function

Press EDIT/NO or ■.

## Display Messages

The following table explains the various messages that appear in the display.

Message	Meaning
Blank Disc	A new (blank) or erased MD has been inserted.
Cannot Copy	An attempt was made to make a second copy from a digitally dubbed MD (see page 33).
Cannot EDIT	An attempt was made to edit the MD during Program or Shuffle Play.
Disc Error	The MD is scratched or missing a TOC. Erase all tracks on a new recordable MD before use (see "Erasing all tracks on an MD" on page 23).
Disc Full	The MD is full (see "System Limitations" on this page).
Impossible	An attempt was made to combine tracks while playing back the first track.
Name Full	The titling capacity of the MD has reached its limit (about 1,700 characters).
NO DISC	There is no MD in the deck.
No Track	The inserted MD has a disc title but no tracks.
Protected	The inserted MD is record-protected.
Retry	The first recording attempt failed due to a disturbance or scratch on the MD, and a second attempt is being made.
Retry Error	Due to vibrations to the deck or scratches on the MD, several recording attempts were made but with no success.
Sorry	An attempt was made to combine tracks that cannot be combined.
STANDBY (flashing)	The contents recorded by timer have disappeared over time and are not be available for saving to disc, or Program Play could not be activated since the program has disappeared over time.

## System Limitations

The recording system in your MiniDisc deck is radically different from those used in cassette and DAT decks and is characterized by the limitations described below. Note, however, that these limitations are due to the inherent nature of the MD recording system itself and not to mechanical causes.

**"Disc Full" lights up even before the MD has reached the maximum recording time (60 or 74 minutes)**

When 255 tracks have been recorded on the MD, "Disc Full" lights up regardless of the total recorded time. More than 255 tracks cannot be recorded on the MD. To continue recording, erase unnecessary tracks or use another recordable MD.

**"Disc Full" lights up before the maximum number of tracks is reached**

Fluctuations in emphasis within tracks are sometimes interpreted as track intervals, incrementing the track count and causing "Disc Full" to light up.

**The remaining recording time does not increase even after erasing numerous short tracks**

Tracks under 12 seconds in length are not counted and so erasing them may not lead to an increase in the recording time.

**Some tracks cannot be combined with others**

Track combination may become impossible when tracks are edited.

**The total recorded time and the remaining time on the MD may not total the maximum recording time (60 or 74 minutes)**

Recording is done in minimum units of 2 seconds each, no matter how short the material. The contents recorded may thus be shorter than the maximum recording capacity. Disc space may also be further reduced by scratches.

**Tracks created through editing may exhibit sound dropout during search operations.**

**Track numbers are not recorded correctly**

Incorrect assignment or recording of track numbers may result (1) when CD tracks are divided into several smaller tracks during digital recording, or (2) while recording certain CDs with the "LEVEL-SYNC" indication on (i.e., the automatic track marking function on).

**“TOC Reading” appears for a long time**

If the inserted recordable MD is brand new, “TOC Reading” appears in the display longer than for MDs that have been used.

**Limitations when recording over an existing track**

- The correct remaining recording time may not be displayed.
- You may find it impossible to record over a track if that track has been recorded over several times already. If this happens, erase the track using the Erase Function (see page 22).
- The remaining recording time may be shortened out of proportion to the total recorded time.
- Recording over a track to eliminate noise is not recommended since this may shorten the duration of the track.
- You may find it impossible to label a track while recording over it.

The correct recorded/playing time may not be displayed during playback of monaural-format MDs.

---

## Troubleshooting

If you experience any of the following difficulties while using the deck, use this troubleshooting guide to help you remedy the problem. Should any problem persist, consult your nearest Sony dealer.

**The deck does not operate or operates poorly.**

- ➔The MD may be damaged (“Disc Error” appears). Take the MD out and insert it again. If “Disc Error” remains, replace the MD.

**The deck does not play back.**

- ➔Moisture has formed inside the deck. Take the MD out and leave the deck in a warm place for several hours until the moisture evaporates.
- ➔The deck is not on. Press POWER to turn the deck on.
- ➔The MD is inserted in the wrong direction. Slide the MD into the disc compartment with the label side up and the arrow pointing towards the opening until the deck grips it.
- ➔The MD may not be recorded (the music calendar does not appear). Replace the disc with one that has been recorded.

**The deck does not record.**

- ➔The MD is record-protected (“Protected” appears). Close the record-protect slot (see page 7).
- ➔The deck is not connected properly to the sound source. Make connections properly to the sound source.
- ➔The recording level is not adjusted properly (in case of input through LINE (ANALOG IN). Turn REC LEVEL to adjust the recording level properly (see page 11).
- ➔A premastered MD is inserted. Replace it with a recordable MD.
- ➔There is not enough time left on the MD. Replace it with another recordable MD with fewer recorded tracks, or erase unnecessary tracks.
- ➔There has been a power failure or the AC power cord has been disconnected during recording. Data recorded to that point may be lost. Repeat the recording procedure.

**The deck does not work during synchro-recording.**

- ➔The currently selected CD player type (CD player or video CD player) does not match the CD player being used. Reset the CD player type (see page 14).

**The sound has a lot of static.**

- ➔Strong magnetism from a television or a similar device is interfering with operations. Move the deck away from the source of strong magnetism.

**Note**

If the deck does not operate properly even after you’ve attempted the prescribed remedies, turn off the power, then reinsert the plug into the power outlet.

## Specifications

System	MiniDisc digital audio system
Disc	MiniDisc
Laser	Semiconductor laser ( $\lambda = 780 \text{ nm}$ ) Emission duration: continuous
Laser output	Less than $44.6 \mu\text{W}^*$ * This output is the value measured at a distance of 200 mm from the objective lens surface on the Optical Pick-up Block with 7 mm aperture.
Laser diode properties	Material: GaAlAs
Revolutions (CLV)	400 rpm to 900 rpm
Error correction	Advanced Cross Interleave Reed Solomon Code (ACIRC)
Sampling frequency	44.1 kHz
Coding	Adaptive Transform Acoustic Coding (ATRAC)
Modulation system	EFM (Eight-to-Fourteen Modulation)
Number of channels	2 stereo channels
Frequency response	5 to 20,000 Hz $\pm 0.3 \text{ dB}$
Signal-to-noise ratio	Over 96 dB during playback
Wow and flutter	Below measurable limit

### Inputs

	Jack type	Input impedance	Rated input	Minimum input
LINE (ANALOG) IN	Phono jacks	47 kilohms	500 mVrms	125 mVrms
DIGITAL IN	Square optical connector jack	Optical wave length: 660 nm	—	—

### Outputs

	Jack type	Rated output	Load impedance
PHONES	Stereo phone jack	10 mW	32 ohms
LINE (ANALOG) OUT	Phono jacks	2 Vrms (at 50 kilohms)	Over 10 kilohms
DIGITAL OUT	Square optical connector jack	-18 dBm	Wave length: 660 nm

### General

Power requirements	120 V AC, 60 Hz
Power consumption	19 W
Dimensions (approx.) (w/h/d) incl. projecting parts	430 × 93 × 280.5 mm (17 × 3 <sup>3</sup> / <sub>4</sub> × 11 <sup>1</sup> / <sub>8</sub> in.)
Mass (approx.)	3.5 kg (7 lbs 11 oz)

Supplied accessories See page 4.

### Optional accessories

Recordable MDs: MDW-60 (60 min), MDW-74 (74 min)  
Optical cable: POC-15A

U.S. and foreign patents licensed from Dolby Laboratories Licensing Corporation.

Design and specifications are subject to change without notice.



## Guide to the Serial Copy Management System

This MD deck uses the Serial Copy Management System, which allows only first-generation digital copies to be made of premastered software via the deck's digital input jack. An outline of this system appears below:

- 1 You can record from digital program sources (CDs, DATs or premastered MDs) onto a DAT tape or recordable MD via digital input jack on the DAT or MD deck. You cannot, however, record from this recorded DAT tape or MD onto another DAT tape or recordable MD via the digital input jack on the DAT or MD deck.

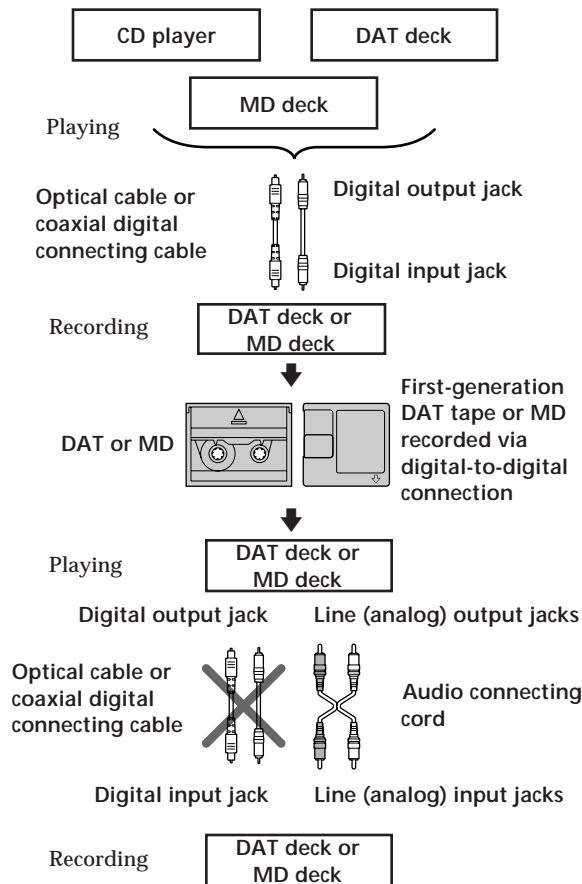

- 2 You can record the digital input signal of a digital satellite broadcast onto a DAT tape or recordable MD via the digital input jack on the DAT or MD deck which is capable of handling a sampling frequency of 32 kHz or 48 kHz. You can then record the contents of this recorded DAT tape or MD (first-generation) onto another DAT tape or recordable MD via digital input jack on the DAT or MD deck to create a second-generation digital copy. Subsequent recording from the second-generation copy onto another recordable DAT tape or MD is possible only through the analog input jack on the DAT or MD deck. Note, however, that on some BS tuners, second-generation digital copying may not be possible.

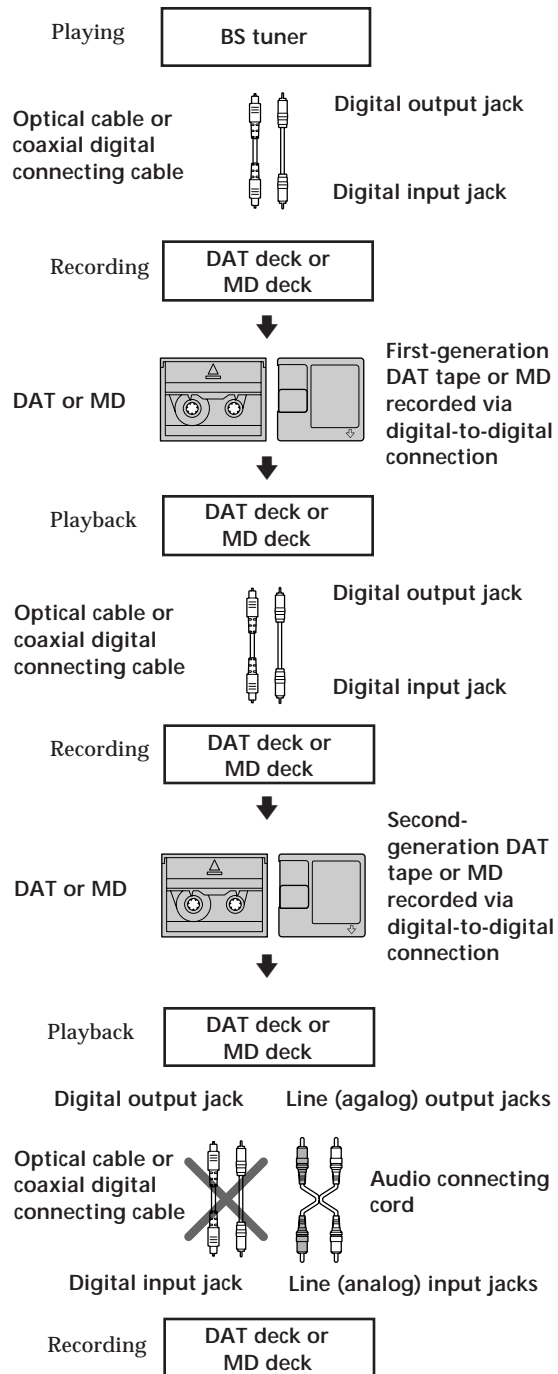

(Continued)

3 You can record a DAT tape or MD recorded via the DAT or MD deck's analog input jack onto another DAT tape or MD via the DAT or MD deck's digital output jack. You cannot, however, make a second-generation DAT tape or MD copy via the DAT or MD deck's digital output jack.

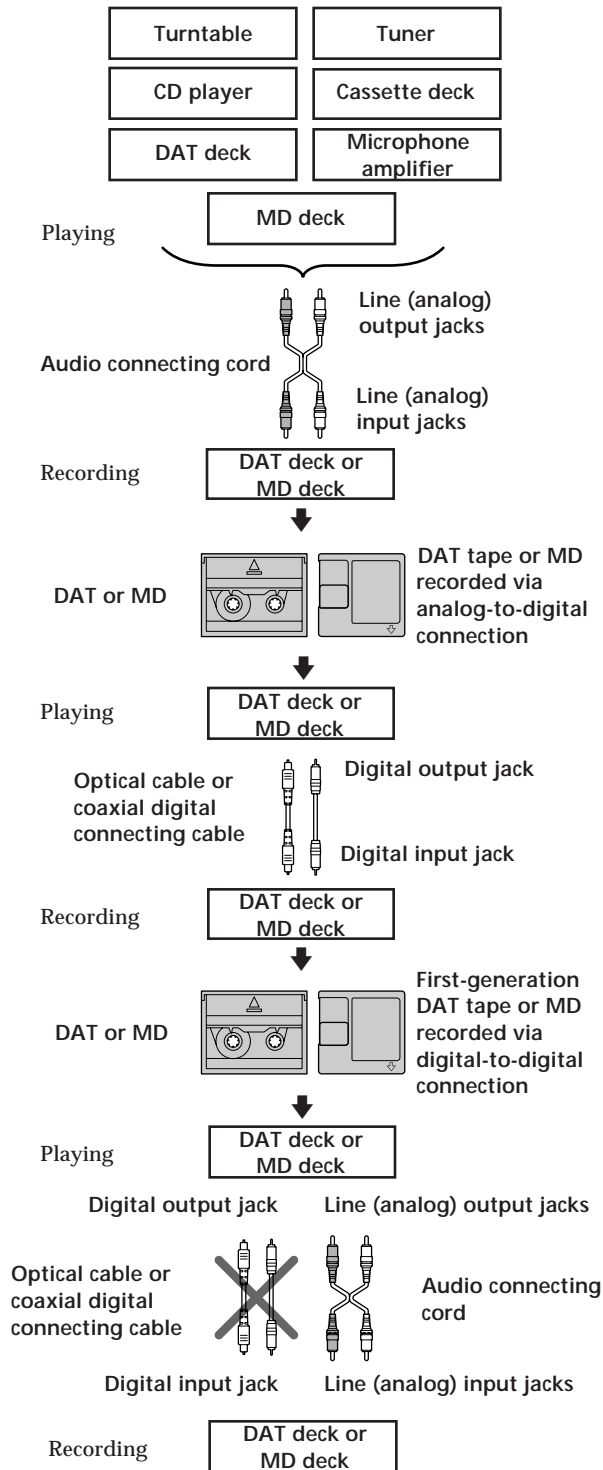

**Index**

**A, B**

- A-B repeat 19
- AMS (Automatic Music Sensor) 17
- Audio connecting cord 4, 5, 33
- Auto cut 10
- Auto pause 21
- Auto space 21

**C**

- CD synchro-recording 14
- Changing
  - an existing title 29
  - order of programmed tracks 20
- Checking
  - order of programmed tracks 20
  - remaining recordable time on the MD 9, 16
- Cleaning 2
- Combining 25

**D**

- Display messages 30
- Dividing 24

**E, F, G**

- Erasing
  - all titles 29
  - all tracks 23
  - a part of a track 23
  - a single track 23

**H**

- Hooking up
  - a digital component 5
  - an analog component 5

**I, J, K**

- Input monitor 10

**L**

- Labeling
  - an MD 26
  - a track 26
- LEVEL-SYNC 9, 12
- Locating
  - a particular point in a track 18
  - a specific track 17

**M, N**

- MD
  - inserting 6, 8
  - premastered 16
  - recordable 6, 16
  - taking out 7, 8
- Moving 26
- Music
  - scan 17
  - synchro-recording 13

**O**

- Optical cable 4, 5, 33
- Optional accessories 32

**P, Q**

- Pausing
  - playback 8
  - recording 7
- Playing
  - normal play 8
  - program play 20
  - repeat play 18
  - shuffle play 19

**R**

- Recording
  - normal recording 6, 7
  - over existing tracks 11
  - time machine recording 12
- Recording level 11
- Record-protect tab 7
- Remote commander (remote) 4

**S**

- Sampling frequency 5, 33
- Sampling rate converter 5
- SCMS (Serial Copy Management System) 9, 33
- Smart space 10
- Specifications 32
- Supplied accessories 4
- System limitations 30

**T**

- Timer
  - playing 21
  - recording 15
- TOC (Table Of Contents) 7, 9, 15, 22
- Track marking
  - automatic track marking 12
  - manual track marking 12
- Troubleshooting 31

**U, V, W, X, Y, Z**

- Undoing the last edit 29

**Names of controls****Buttons**

- A↔B 18
- Alphabet/Number 17, 20, 28
- A.SPACE 21
- CD PLAYER  14
- CHAR 28
- CLEAR 20, 28
- CONTINUE 19, 20
- DISPLAY 14, 16
- DISPLAY/CHAR 9, 16
- EDIT/NO/YES 10, 12, 22 to 26, 29
- ≡ EJECT 7, 8, 10
- M.SCAN 17
- MUSIC SYNC 13, 29
- NAME 28
- NUM 28
- PLAY MODE 19 to 21
- PROGRAM 20
- REC (recording) 7, 10, 12, 29
- REPEAT 18
- SCROLL 16
- SHUFFLE 19
- STANDBY 14, 29
- START 14
- STOP 14
- T.REC 13
- ▷ (play) 7, 8, 17, 19 to 21
- ⏸ (pause) 7, 8, 21, 24
- (stop) 7, 8, 15, 19, 20, 23
- (recording) 29
- ◀◀/▶▶ (manual search) 18, 26 to 28
- ⏮/⏭ (AMS: Automatic Music Sensor) 8, 11, 17, 18 to 20, > 25 17, 20

**Switches**

- INPUT 6, 10
- POWER 6, 8
- REC MODE 6
- TIMER 15, 21

**Connectors**

- DIGITAL IN/OUT 5, 9, 10

**Controls**

- ⏮ AMS ⏭ 8, 11, 13, 17, 20, 22 to 26
- PHONE LEVEL 8
- REC LEVEL 7, 11

**Indicator**

- POWER 6, 8, 14

**Jacks**

- LINE (ANALOG) IN/OUT 5, 9, 10
- PHONES 8, 10

**Others**

- Display 16
- Music calendar 16
-  4

